

# Operating Manual UFR1001E

updated: 2023-09-28 /Sc  
from Firmware: 0-38



For more information and help about this product please scan the [QR-Code](#) or choose the following link: [UFR1001E](#)

Operating manual, Quick guide, Datasheet, Connection diagram, CAD Data  
Firmwareupdates, FAQ, Videos about installation and settings, Certificates

- NA-protection according to VDE-AR-N 4105, power generators at the low voltage grid
- Use in medium and high voltage grid to BDEW + VDE-AR-N 4110 / 4120



## Since Firmware 0-09:

Default setting program 2 for low voltage VDE-AR-N 4105:2018-11  
4 new programs (11-14) for medium voltage according to 4110:2018-11

## New Firmware 0-13:

Switching-on behaviour adjustable **UFon**, easy measurement of disengaging ratio **rUEF**

## New Firmware 0-14:

Monitoring of zero voltage  $U_0$  (ANSI 59v0)  
Program 10 for Austria according to TOR producers type A, B, C, D  
Program 16 for Belgium according to Synergrid C10 / C11

## New Firmware 0-15:

Function ROCOF revised  
New factory settings in program Pr16 for Belgium according to Synergrid C10 / C11

## New Firmware 0-16:

New factory settings in Pr15, NA/EEA-NE7 CH 2020

## New Firmware 0-17 / 0-37:

Program 16 for Belgium: automatic narrow frequency window based on local voltage criteria **nFr**  
New pre-sets for Australia, Finland, France, Ireland, Netherlands and South Africa  
Input E1-E2 (standby) also as opener

## New Firmware 0-38:

Starting conditions **StEt**, restart attempts adjustable **RtEt**, disengaging ratio **rUEF** for frequency

(Display of the firmware version: **Inf0** → **Fnr** or press "Set" for >10s)

## Certificates see:

<https://www.ziehl.com/en/products/detail/UFR1001E-54>

## Table of contents

<b>1</b>	<b>General Notes</b>	<b>3</b>
<b>2</b>	<b>Display and controls</b>	<b>4</b>
<b>3</b>	<b>Application and brief description</b>	<b>5</b>
<b>4</b>	<b>Summary of the functions</b>	<b>6</b>
<b>5</b>	<b>Connection diagrams</b>	<b>7</b>
<b>6</b>	<b>Important information</b>	<b>8</b>
<b>7</b>	<b>Assembly</b>	<b>8</b>
<b>8</b>	<b>Detailed description</b>	<b>9</b>
8.1	Description of the connections	9
8.2	Functional characteristics	10
<b>9</b>	<b>Commissioning</b>	<b>11</b>
9.1	Program setup	11
9.2	Control chart	13
9.3	Description of the parameters	14
9.4	Display mode (last decimal point off)	15
9.5	Menu mode (last decimal point on)	15
9.6	Configuration mode (last decimal point flashes)	15
9.7	Starting conditions	15
9.8	Switching conditions	16
9.9	Disengaging ratio	16
9.10	Monitoring of zero voltage	16
9.11	Narrower frequency window based on local voltage criteria	16
9.12	Test mode (timekeeping only activated and connected feedback contacts)	17
9.13	Alarm counter	17
9.14	Cumulative alarm time (display in hours)	17
9.15	Alarm memory	18
9.16	Standby counter and standby time	18
9.17	Code lock	18
9.18	Sealing	19
9.19	Simulation	19
9.20	Possible indications in display	20
<b>10</b>	<b>Technical Data</b>	<b>21</b>
<b>11</b>	<b>Troubleshooting and measures</b>	<b>24</b>
<b>12</b>	<b>Maintenance and repair</b>	<b>25</b>
<b>13</b>	<b>Construction form V6</b>	<b>25</b>
<b>14</b>	<b>Adjustment values table VDE-AR-N 4105:2011, Low Voltage Pr 1+7</b>	<b>26</b>
<b>15</b>	<b>Adjustment values table BDEW June 2008, acc 3.2.3.3-1, Medium Voltage Pr 3-6</b>	<b>26</b>
<b>16</b>	<b>Adjustment values table VDE-AR-N 4105:2018-11, Low Voltage 6. table 2, Pr 2</b>	<b>26</b>
<b>17</b>	<b>Adjustment values (VDE-AR-N 4110:2018-11 Medium Voltage / VDE-AR-N 4120:2018-11 High Voltage) higher protection Pr 11+12</b>	<b>27</b>
<b>18</b>	<b>Adjustment values VDE-AR-N 4110:2018-11, Medium Voltage Unit Protection Pr 13+14</b>	<b>27</b>
<b>19</b>	<b>Disposal</b>	<b>27</b>

<b>20</b>	<b>Default settings of the programs.....</b>	<b>28</b>
20.1	VDE-AR-N 4105:2011+2018 + BDEW .....	28
20.2	VDE-AR-N 4110:2018-11 + VDE-AR-N 4120:2018-11.....	30
20.3	TOR Erzeuger Typ A,B,C,D + NA/EEA-NE7 CH 2020 + C10/C11 + G98(G83/2)+G99(G59/3)....	32
20.4	SFS-EN50549-1+2:2019 + EN50549-1 2-stage + NEN-EN50549-1:2019 + VDE 0126 VFR2019	34
20.5	NRS097 + AS4777,2 .....	36

## 1 General Notes

Compliance with the following instructions is mandatory to ensure the functionality and safety of the product. If the following instructions given especially but not limited for general safety, transport, storage, mounting, operating conditions, commissioning and disposal / recycling are not observed, the product may not operate safely and may cause a hazard to the life and limb of users and third parties.

Deviations from the following requirements may therefore lead both to the loss of the statutory material defect liability rights and to the liability of the buyer for the product that has become unsafe due to the deviation from the specifications.

## 2 Display and controls

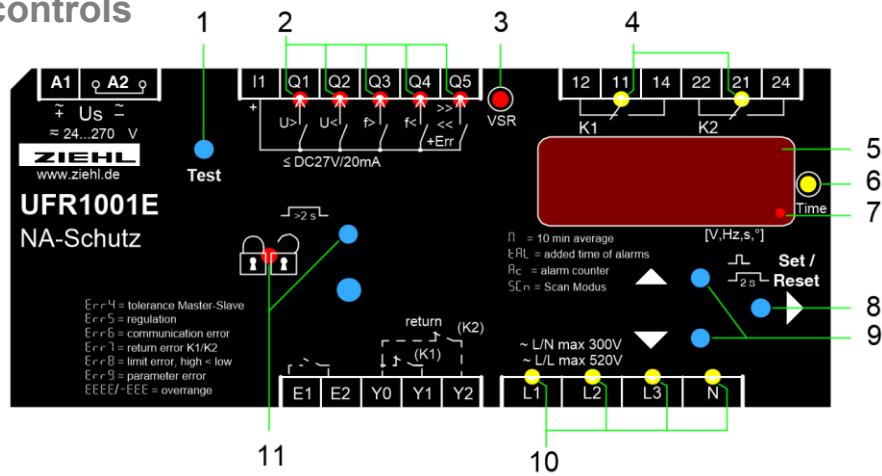

### 1 Test button

Press briefly	Display <a href="#">test-menu</a> Relay K1 ( $t_{5t1}$ ) or relay K2 ( $t_{5t2}$ ) can be tested independently. (3min without a button is pressed = go back to the normal mode)
---------------	---

### 2 LEDs frequency / voltage limit value undercut / exceeded (red)

On, $RL$ or $RL \Pi$	Limit value undercut / exceeded
FLASHES, $RL$ or $RL \Pi$	Reset delay $daF$ counting down

### 3 LED vector surge (VSR, red)

ON, $RL$	Threshold value for vector shift exceeded
FLASHES, $RL$	Reset delay $daF$ counting down

### 4 LEDs relay status (yellow)

OFF	Relay is released
ON	Relay operating

### 5 Digital display 4-digits (red)

Depending on program, display of current voltage, frequency, vector shift, average value
Displays the alarm signals, e.g. $RL$ , $RL \Pi$
Displays the errors with error code e.g. $Err9$

### 6 LED Time (yellow)

ON	A time is displayed
FLASHES	Function $r_{uEF}$ active

### 7 Last decimal point (red)

OFF	Display mode
Illuminated	Menu mode
Flashes	Configuration mode

### 8 Set/Reset key (in display mode, normal state)

Press briefly	Display of next measured value / alarm counter
Press for > 2 s	Reset, quit error messages
Press for > 4 s	Displays the program, e.g. $Pr 1$
Press for > 10 s	Displays the software version, e.g. $0-05$

### 9 Up / Down key (in display mode, normal state)

Press briefly	Change to the menu mode, display of alarm memory (Down) / cumulative time of alarms, standby counter, standby time (Up), pushing Set button for $\geq 2$ s resets the stored values
Press for > 2 s	Display of MAX (Up) / MIN (Down) - measured values, additional pushing of Set button for $\geq 2$ s deletes the stored values

## 10 LEDs measurement allocation (yellow)

LEDs	Measured value
Lx and N ON	Voltage value (L1 against N, L2 against N, L3 against N)
Lx and Ly ON	Voltage value (L1 against L2, L2 against L3, L1 against L3)
Lx FLASHING quickly	Vector surge (L1, L2, L3)
L1 FLASHING	Frequency

## 11 Sealable button + LED

Press for > 2 s	Lock / Unlock
 LED red	Settings and simulation mode are locked, While attempting to set, <b>Loc</b> is displayed for 3s
LED green	Setting and simulation enabled

## 3 Application and brief description

The grid- and plant protection device UFR1001E monitors voltage and frequency in plants for own generation of electricity. It complies with the requirements of VDE-AR-N 4105:2018-11, VDE-AR-N 4110:2018-11, VDE-AR-N 4120:2018-11, G59/3, G83/2, ÖVE/ÖNORM E 8001-4-712:2009 and other standards for generators connected to the public grid.

The UFR1001E is a dual-channel device and thus one-fault-proof. The function of the output-relays and of the connected switches can be monitored with feed-back contacts. When a connected switch does not switch off, the UFR does not switch on again. When a switch does not switch on it makes restarts (adjustable, 0...3) and thus improves availability of monitored plant.

The limits are pre-set according to VDE-AR-N 4105\_2011-08, VDE-AR-N 4105:2011-11 and other standards. They can be changed if required and be protected with a code and/or a seal.

With a test-button the function of the connected switches can be tested, and their switching-time can be measured.

The standby input allows a remote shutoff e.g. with a RCR.

## 4 Summary of the functions

- Under and overvoltage monitoring 15...520 V
- Measuring phase-neutral or phase-phase
- Monitoring of under- and over frequency 45...65 Hz
- Monitoring of quality of voltage (10-minutes-average)
- Monitoring of vector shift 2...65°
- Monitoring of rate of change of frequency (ROCOF,  $df/dt$ ) 0,100...5,000 Hz/s
- Monitoring of zero voltage  $U_0$
- One-fault-proof with monitoring of connected switches (defeat able when using the integrated switch of pv and battery inverter acc. to DIN EN 62109 (VDE 0126-4))
- automatic restarts at switch-on error (adjustable, 0...3)
- Passive anti-islanding protection acc. to ch. 6.5.3 and app. D2
- Switching delay adjustable 0.05 ... 300 s
- Switching back delay adjustable 0 ... 6.000 s
- Switching back delay at alarms <3 s: 5 s
- Standby input (adjustable as opener/closer) with counter and time saves

Preset values acc. to

- VDE-AR-N 4105:2018-11 (Pr2), VDE-AR-N 4105\_2011-08 (Pr1)
- VDE-AR-N 4110 + 4120:2018-11 (PR11-14) and BDEW (Pr 3-6)
- G59/3 and G83/2 for Great Britain
- ÖVE standard for Austria
- VSE/EEA-CH 2014 for Switzerland
- Alarm counter for 100 alarms (trip value, cause and rel. time stamp)
- Record of added times of alarms
- Input for standby with counter and recording of time
- Test button and simulation with measuring of switching-times
- Sealing, all values can be read-out when sealed
- Easy installation and programming with pre-set programs
- Housing for DIN-rail-mount, 105 mm wide, mounting height 66 mm

## 5 Connection diagrams

You can get more connection diagrams via the QR code or below

[https://www.ziehl.com/en/products/dl/Example\\_connection\\_plans-3742/?task=download](https://www.ziehl.com/en/products/dl/Example_connection_plans-3742/?task=download)

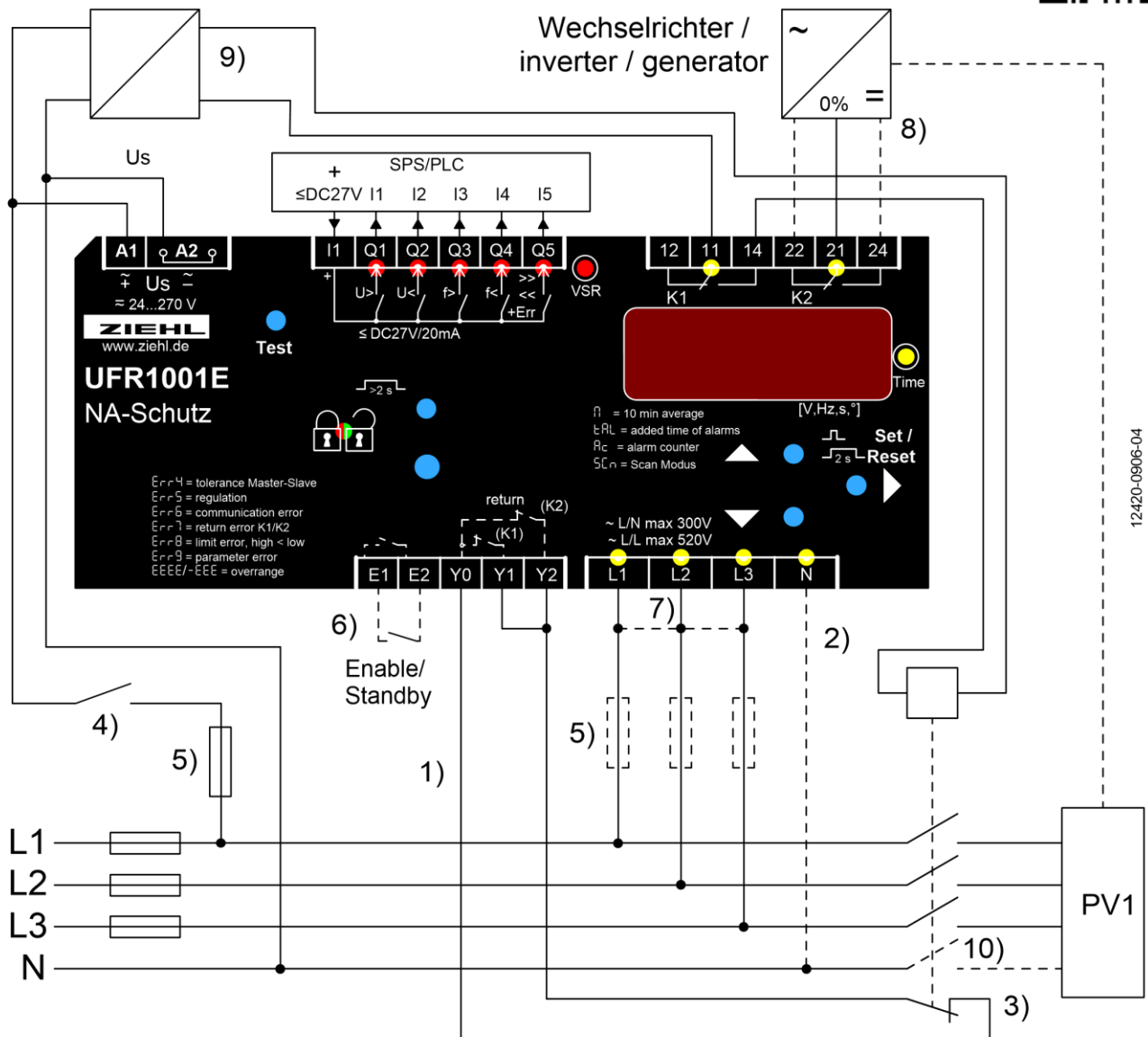

12420-0906-04

- 1) Feedback contacts not connected: set **rEL** → **trEL** → **OFF**.
- 2) N connected → only for programs with N
- 3) NC- or NO-contacts can be connected, self-learning when switching on
- 4) Switch off the plant without recording an alarm, e.g. with contact of a ripple control receiver
- 5) Fuses only when line protection necessary, e.g. 16 A
- 6) Contact closed an **u5r** → **5b95**. (default setting) = Standby, K1+2 switched-off (e.g. by ripple control receiver or clock, ...)  
Contact closed and **u5r** → **on** = repressed vector shifts (e.g. when switching on ...),  
contact closed and **u5r** → **Y192** = no evaluation of the feedback contacts (e.g. for synchronisation, ...)
- 7) 1 phase Application connect L1-L2-L3, 2 phase Application L1 / L2+L3 (only Pr 5, 7, 10, 13, 20)
- 8) Additional switch-off of self generation plant.  
Single-fault safety: shutdown of the self generation plant e.g. by ripple control input 0% with K2. Use coupling relays for contact multiplication of if safe isolation is required.  
This second shutdown path must be tested separately during commissioning. (**ts2**)
- 9) Power supply / buffering. Switches have to withstand undervoltage for min.3 s (FRT)
- 10) TT-system: switch all line conductors and N, TN-system: only switch line conductor

## 6 Important information



**A marked switch and a protective device must be provided in the supply line in the vicinity of the device (easily accessible) as a disconnecting element.**

Flawless and safe operation of such a device requires proper transport and storage, professional installation and later commissioning along with operation as intended.

Only persons who are familiar with the installation, commissioning and operation of the device and who are correspondingly qualified for their job are permitted to work on the device. They must comply with the contents of the operating manual, the instructions attached to the device and the pertinent safety regulations for the erection and operation of electrical equipment.

The devices are built and certified in accordance with EN 60255 and leave the factory in a safe and technically flawless condition. To maintain this condition they must comply with the safety regulations marked in the operating manual with the headline "Caution". Failure to follow the safety regulations can lead to death, bodily injury or property damage to the device itself and to other devices and equipment.

If the information contained in the operating instructions/operating manual are not sufficient, please contact us directly or contact your responsible agency or representative.

Instead of the industrial norms and stipulations stated in the operating manual and applicable in Europe you must comply with the valid and applicable regulations in the country of utilisation if the device is used outside of the area of application.



### **WARNING**

**Hazards electrical voltage!**

**Can lead to an electric shock and burns.**

**Disconnect and de-energize before working on the system and the device.**

**Comply with the maximum permissible temperature when installing in a switch cabinet. Ensure sufficient clearance to other devices or heat sources. If cooling is inhibited, e.g., through close proximity to devices with increased surface temperature or interference with the cooling-air current, the permissible ambient temperature is decreased.**



### **Caution!**

Before you apply mains voltage to the device, make sure that the permissible control voltage **Us** on the side rating plate matches the mains voltage connected to the device!

## 7 Assembly

The device can be mounted:

- Distribution panel or control panel on 35 mm rail according to EN 60715



## 8 Detailed description

### 8.1 Description of the connections

Connection	Description
A1 and A2	Rated control supply voltage $U_s$ , see Technical Data
11, 12, 14; 21, 22, 24	Relay K1 and K2
E1 – E2 Enable – Input	Volt-free contact
	$u5r$ . → $oFF$ . , no function
	$u5r$ . → $on$ . , E1-E2 closed: Vector shift active but not evaluated, monitoring of feedback contacts off for use with generator (mains synchronization)
	$u5r$ . → $5b59$ . , E1-E2 closed: K1 and K2 off (standby), vector shift off
	$u5r$ . → $5b9a$ . , E1-E2 opened: K1 and K2 off (standby), vector shift off
	$u5r$ . → $9192$ . , E1-E2 closed: Feedback contacts no evaluated, vector shift off, when using with generator (mains synchronization)
Y0, Y1, Y2 Inputs, feedback contacts	Volt-free n/o or n/c contact, self-learning when switching on
	Set value > turn-on time section switch under $rEL$ . → $ErEL$ . / can switch-off if not connected or if external devices/switches can activate the section switch ( $oFF$ . )
I1	Supply voltage for digital outputs, max. 27 V DC
Q1...Q4	Digital output over-/under voltage/-frequency, Q3 + Q4 = ROCOF
Q5	Digital output error, in Programs with >> and << additionally the 2nd threshold value
L1, L2, L3, N	Phase L1, L2, L3 and neutral conductor

## 8.2 Functional characteristics

Functional characteristics	Explanation
VSR display value	The highest measured value is always displayed. The display value is reset to 0 by deleting the max. value and when resetting into the go (good) state.
Delay Enable On time	Runs down when starting the unit and after opening the enable input; during this time there is no evaluation of the vector shift
Reset time	When a reset time $d_{oF}$ is running, it is always counted down in the display (shortest one first)
Reset	Use the Reset key or interrupt the control voltage for > 2 s (comply with reset delay)
Display mode $S_{cN}$	After the last measurement it switches into the scan mode; this is indicated by the display $S_{cN}$ . All measurements will now be displayed cyclically for the time set in $d_i t$ .
MIN / MAX values	All min and max values are saved zero-voltage maintained (non-volatile).
Tripping time (only with feedback contacts connected)	Connecting the feedback contacts enables measuring of the shut-down time. After a tripping test via the test menu (button test) and selection of the trip circuit (see <a href="#">test mode</a> ), the respective tripping time is displayed. (Pr2 and Y1+Y2 bridged, display for K1 only) The display duration is max. 3 minutes or until button test is pressed. The display resolution is 1ms.  Total shut-down time = Tripping time + Response time $d_{RL}$ .  After a shut-down in the simulation mode the total shut-down time is displayed until the button is pressed again) The longer time of both channels is always displayed.
Alarm counter	The unit saves max 100 alarms (cause, measurement value, at operating time). The LEDs indicate the cause; the tripping value that led to the alarm each stands in the 7-segment display. Alternately the time difference, current operating time – tripping operating time is displayed. (how long ago the alarm triggered)
Cumulative alarm time $t_{AL}$	The cumulative alarm time TAL indicates how long the relay was switched off due to an alarm. It is recorded with a resolution of 1 minute and only when the control voltage is applied. Query: In the display mode $\blacktriangleright$ button to $R_c$ is displayed. 1x $\blacktriangle$ button = Cumulative alarm time $t_{AL}$
Standby mode $u_{5r} \rightarrow 5b95$ (closer) $u_{5r} \rightarrow 5b9a$ (opener)	If E1-E2 are closed (e.g., by ripple control receiver, timer, dimmer), Relays K1 and K2 are switched off. The number and duration of the shut-downs is recorded. Query: In the display mode $\blacktriangleright$ button to $R_c$ is displayed. 2x $\blacktriangle$ button = Standby counter $5t69$ . 1x $\blacktriangle$ button = Standby time $5t69$
synchronization mode $u_{5r} \rightarrow 9192$	If E1-E2 are closed, the evaluation of the feedback contacts is suppressed. That means when using generators, a section switch can be used for mains synchronization.
Automatic restart attempts (adjustable, 0...3) $R_{tE}$	If there is an error by the feedback contacts $E_{r7}$ , restart attempts are automatically performed in an interval of 10s. False triggering by undervoltage trips (e.g. during a thunderstorm) do not lead to permanent shut-down.
Frequency undervoltage protection $U_{oNF}$	If one of the measured voltages less than $U_{oNF}$ , the frequency evaluation is interrupted until all voltages have exceeded $U_{oNF}$ . (does not apply to device start / apply of the control voltage)

## 9 Commissioning

### 9.1 Program setup

The suitable program must be set on the UFR1001E in accordance with the application. If the UFR1001E is sealed/locked (red LED illuminated), the sealing has to be deactivated first.

Pr	Connection	Limit	Voltage	Country / Standard
* 2	3 AC with N	<u>Low voltage</u> 2x over voltage, 2x under voltage 2x over frequency, 2x under frequency 10min average value, 1x vector shift 1x ROCOF, zero voltage	230V	 VDE-AR-N 4105:2018
1	3 AC with N	<u>Low voltage</u> 1x over voltage, 1x under voltage 1x over frequency, 1x under frequency 10min average value, 1x vector shift 1x ROCOF, zero voltage	230V	 VDE-AR-N 4105:2011
7	2/1 AC with N			
11(3)	3 AC with N	<u>Medium voltage</u>	57,7V	 VDE-AR-N 4110:2018 VDE-AR-N 4120:2018 (BDEW June 2008 by 3.2.3.3-1)
12(4)	3 AC without N	2x over voltage, 2x under voltage	100V	
13(5)	3/2/1 AC with N	2x over frequency, 2x under frequency 10min average value, 1x vector shift 1x ROCOF, zero voltage	230V	
14(6)	3 AC without N		400V	
10	3/2/1 AC with N	2x over voltage, 2x under voltage 2x over frequency, 2x under frequency 10min average value, 1x vector shift 1x ROCOF, zero voltage	230V	 TOR Erzeuger Typ A,B,C,D
15	3 AC with N		230V	 NA/EEA-NE7 CH 2020
20	3/2/1 AC with N	2x over voltage, 2x under voltage	230V	 G98(G83/2) + G99(G59/3)
21	3 AC without N	2x over frequency, 2x under frequency	400V	
22	3 AC with N	10min average value, 1x vector shift	63,5V	
23	3 AC without N	1x ROCOF, zero voltage	110V	
16	3 AC with N	1x over voltage, 1x under voltage 1x over frequency, 1x under frequency 1x ROCOF, zero voltage Narrower frequency window	230V	 Synergrid C10/C11
30	3 AC with N	2x over voltage, 2x under voltage	230 V	 SFS-EN50549-1+2:2019
31	3 AC without N	2x over frequency, 2x under frequency 10min average value, 1x vector shift 1x ROCOF, zero voltage	400 V	
32	3 AC with N		230 V	 EN50549-1 2-stage
33	3 AC without N		400 V	
34	3 AC with N		230V	 NEN-EN50549-1:2019
36	3 AC with N		230V	 VDE 0126 VFR2019
40	3 AC with N		230 V	 NRS097
41	3 AC without N		400 V	
42	3 AC with N		230 V	 AS4777,2

\* default setting

### Adjustment process:

If present, remove seal (only authorised person)

- Apply control supply voltage at A1-A2
- Slightly lift the key cover and turn 180°
- Actuate the small blue button by firmly pressing the button cover (LED starts flashing) until the green LED  is illuminated.

### Sealing is deactivated

- Press ▲ button 1x → display I n F a.
- Press ▶ button 5x → display P r l.
- Set the program with the buttons ▲ ▼
- Press ▶ button 1x → display n o.
- Press ▼ button 1x → display Y E S.
- Press ▶ button  
→ Device resets and starts with the newly selected program

Hint: When changing programs, all parameters of the selected program are reset to “default settings“ (see table „Default settings“). **Only change the parameters after having selected the correct program.**

## 9.2 Control chart

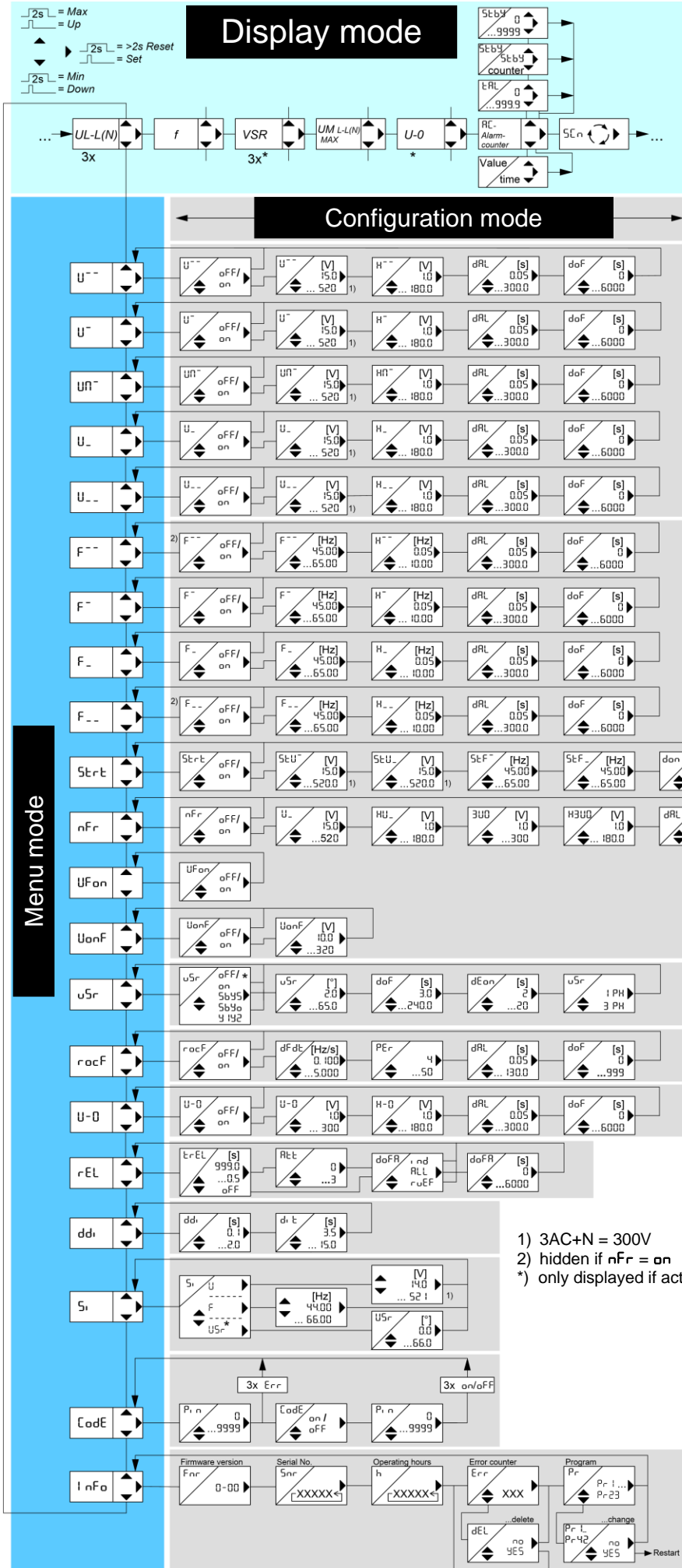

Pr	Connection	Country/Stand
2	3 AC + N	VDE-AR-N 4105:2018
11	3 AC + N	VDE-AR-N 4110:2018 4120:2018
12	3 AC	
13	3/2/1 AC + N	
14	3 AC	
3	3 AC + N	BDEW Juni 2008 nach 3.2.3.3-1
4	3 AC	
5	3/2/1 AC + N	
6	3 AC	
1	3 AC + N	VDE-AR-N 4105:2011
7	2/1 AC + N	TOR Erzeuger Typ A,B,C,D
10	3/2/1 AC + N	
15	3 AC + N	NA/EEA-NE7 CH 2020
20	3/2/1 AC + N	G98(G83/2) + G99(G59/3)
21	3 AC	
22	3 AC + N	
23	3 AC	Synergrid C10/C11
16	3 AC + N	
30	3 AC + N	SFS-EN50549-1+2:2019
31	3 AC	

32	3 AC + N	EN50549-1 2-stage
33	3 AC	
34	3 AC + N	NEN-EN50549-1:2019
36	3 AC + N	VDE 0126 VFR2019
40	3 AC + N	NRS097
41	3 AC	
42	3 AC + N	AS4777,2

[ ] = Unit  
Up/Down simultaneously sets the value to the lowest value.

Code-Reset = 2 s Set when mains are switched on. (Pin = 504)

### Error messages:

Err4 = Tolerance Master Slave  
 Err5 = Internal control  
 Err6 = Communication  
 Err7 = Contactor feedback contacts K1/K2  
 Err8 = Limit error  
 Err9 = Parameter error

### 9.3 Description of the parameters

Parameters	Display	Explanation	Adjustment range
Limit value	U <sup>---</sup> U <sup>-</sup> U <sub>-</sub> U <sub>--</sub> U <sub>n</sub>	Voltage limit value	15.0 ... 300 15.0 ... 520
Limit value	U <sub>onF</sub>	Limit value for voltage (L1/2/3 < U <sub>onF</sub> = frequency protection off)	10.0 ... 320
Limit value	F <sup>---</sup> F <sup>-</sup> F <sub>-</sub> F <sub>--</sub>	Frequency limit value	45.00 ... 65.00
Limit value	StU <sup>-</sup> StU <sub>-</sub> StF <sup>-</sup> StF <sub>-</sub>	Starting conditions limit value	15.0 ... 300 15.0 ... 520 45.00 ... 65.00
Limit value	dFdt	ROCOF, df/dt limit value	0.10 ... 5.00
Limit value	U-0	zero voltage limit value	1.0 ... 300
Limit value	3U0	Limit zero voltage 3U <sub>0</sub>	1.0 ... 300
Hysteresis	H	253V (Limit) – 3V (Hysteresis) = 250V (Reset value)	1.0 ... 180.0 0.05 ... 10.00
Hysteresis	HU <sub>-</sub> H3U0	hysteresis undervoltage (menu nFr) hysteresis zero voltage 3U <sub>0</sub> (menu nFr)	1.0 ... 180.0
Response time (delay Alarm)	dAL	An alarm is suppressed for the set time (seconds)	0.05 ... 300.0 0.05 ... 180.0
Turn-on time (delay Off)	doF doFR	Reset is delayed for the set time, also during voltage recovery, this time (seconds) is always counted down in the display doFR : doF for U+f together	0 ... 6000
Enable time (delay On)	dEon	There is no evaluation of the vector shift during this time; starts with the application of the control voltage and when opening the Enable input	2 ... 20
VSR	uSr	1 Ph : a vector surge on one phase leads to an alarm 3 Ph : a vector surge on all phases simultaneously leads to an alarm	1 Ph ... 3 Ph
Periods	PEr	Measuring time ROCOF, (4=sensitive, 50=insensitive) Response time= PEr * Period duration + dAL	4 ... 50
delay Display	ddi	Interval during which the display is updated in the display mode	0.1 ... 2.0

## 9.4 Display mode (last decimal point off)

In the display mode, the UFR1001E is in its normal state; here, depending on the program, the actual voltage, the highest actual 10 minute mean value, the frequency or the vector surge is displayed. In addition, the alarm signals (e.g. **RL** , **RL n** ) and error codes (e.g. **Err9** ) are displayed.

Function button Set / Reset	<u>Press briefly:</u> Switches the measurement, alarm counter
	<u>Press for &gt; 2 s:</u> Resets after error (not possible if doF Reset delay is counting down)
	<u>Press for &gt; 4 s:</u> Displays the program, e.g. <b>Pr 1</b>
	<u>Press for &gt; 10 s:</u> Displays the software version, e.g. <b>0-05</b>
Function key Up / Down	<u>Press briefly:</u> Change into the menu mode, Display alarm counter: Down = Query the memory Up = Query the cumulative alarm time
	<u>Press for ≥ 2 s:</u> Displays MAX and MIN measurements, additionally pressing the Set key for ≥ 2 s deletes the saved values

## 9.5 Menu mode (last decimal point on)

The menu mode is used to select the menu items. If no key is pressed for 30 s, one automatically returns to the display mode.

Function button Set / Reset	<u>Press briefly:</u> Change into the configuration mode
	<u>Press for ≥ 2 s:</u> Returns to the display mode (the most recently set values are then applied)
Function key Up / Down	<u>Press briefly:</u> Select menu item; changes into the display mode

## 9.6 Configuration mode (last decimal point flashes)

In the configuration mode you can set the value of a parameter. The display alternates between the parameter relation and the currently set value until one of the Up/Down buttons is pressed, which changes the value of the parameter. If no key is pressed for 2 s the display starts alternating again.

If no key is pressed for 30 s (simulation mode 15 min) one automatically returns to the display mode (the most recently set value is applied during this)

Function button Set / Reset	<u>Press briefly:</u> The settings are taken over; continue to next parameter. Changes into menu mode after the last parameter
	<u>Press for ≥ 2 s:</u> Returns to the display mode (the most recently set values are then applied)
Function key Up / Down	<u>Press briefly/long:</u> Value change of the parameter (slow/fast)

**Hint:** Simultaneously pressing the Up and Down keys resets the adjustable value to zero. If the Up or Down button is kept pressed while setting the value the change in the display is accelerated.

## 9.7 Starting conditions

The limit values of the parameters start voltage  $U > S_{tU}^-$ , start voltage  $U < S_{tU}_-$ , start frequency  $f > S_{tF}^-$  and start frequency  $f < S_{tF}_-$  must be met once after the device has started so that the relays switch on after the delay time **don** has elapsed (only if the alarm "starting conditions" **S\_{tE} = on** ).



## 9.8 Switching conditions

After switching-on the auxiliary voltage the relays only switch-on when the switch-back limit (switching conditions / limit  $\pm$  hysteresis) of all alarms have been reached.

With the parameter **UFon**, the behaviour of the switching conditions after a off-limit violation can be determined:

**UFon**  $\rightarrow$  **on** the switch-back limits of the alarms undervoltage, underfrequency and overfrequency must be fulfilled for switch-on

**UFon**  $\rightarrow$  **off** only the switch-back limit of triggered alarm must be fulfilled for switch-on

## 9.9 Disengaging ratio

The disengaging ratio is the ratio between the disengaging value and the start value. The start value is the value at which the limit is recognized and the on-delay time **dRL** starts. The disengaging value is the value at which **dRL** stops running if it reached before **dRL** expires.

Activate the **rUEF** function for simple measurement of the disengaging ratio.

Function while **rUEF** is active:

When limit value is reached (= **dRL** starts)  $\rightarrow$  relay OFF.

When the disengaging value is reached (= **dRL** cancelled)  $\rightarrow$  relays ON.

Disengaging ratios can be checked for  $U_{>>}$ ,  $U_{>}$ ,  $U_{<}$ ,  $U_{<<}$ ,  $f_{>>}$ ,  $f_{>}$ ,  $f_{<}$  and  $f_{<<}$  (not for zero voltage and 10min average value). For testing e.g.  $U_{>>}$ ,  $U_{>}$  must be switched "off."

**rUEF** can be selected under the menu item **rEL**  $\rightarrow$  **doFR**. The "time" LED flashes when **rUEF** is active. To switch off the function select **rEL**  $\rightarrow$  **doFR**  $\rightarrow$  **RL** and confirm with "set". The delay-off time **doF** for all alarms can be set here to the values required by the system operator. The function switches off automatically after 600 s.

## 9.10 Monitoring of zero voltage

The zero voltage  $U_0$  (ANSI 59v0) is the modulus of the zero-component system,  $U_0 = |\underline{U}_0|$ . The zero-component system is an operand from the phase-to-neutral voltages ( $U_{L1}, U_{L2}, U_{L3}$ ) and the phase angles ( $\varphi_{L12}, \varphi_{L23}, \varphi_{L31}$ ) and is defined by the following equation:  $\underline{U}_0 = \frac{1}{3} * (\underline{U}_{L1} + \underline{U}_{L2} + \underline{U}_{L3})$ .

Activate the **U-0** function for simple measurement of the zero voltage. All other parameters such as limit value, hysteresis and delay times can be set under this menu item.

Function while **U-0** is active:

When limit value is reached (= **dRL** starts)  $\rightarrow$  relay OFF. This state is indicated by flashing-on the LED and switching-on of the digital outputs Q1 and Q2, respectively.

When the fallback value is reached (= **doF** starts)  $\rightarrow$  relay ON. LED/ digital outputs Q1+Q2 off.

## 9.11 Narrower frequency window based on local voltage criteria

**nFr**: "narrower frequency range".

If one of the set limit values is violated (fallen below undervoltage  $\underline{U}_-$ ,  $3U_0$  voltage exceeded), alarms  $F_{--}$  (overfrequency) and  $F_{--}$  (underfrequency) are automatically switched on after **dRL** has elapsed.

When the switch-back values are reached (undervoltage  $\underline{U}_- +$  hysteresis und  $3U_0$  voltage - hysteresis), alarms  $F_{--}$  (overfrequency) and  $F_{--}$  (underfrequency) are automatically switched off again after **doF** has expired.

If the function is switched off (**nFr** = **off**), the frequency alarms  $F_{--}$  and  $F_{--}$  get their original function again.



### 9.12 Test mode (timekeeping only activated and connected feedback contacts)

After pressing the Test button, the test-menu is displayed and both trip circuits can be tested. If additionally, feedback contacts of the switch are connected to the UFR100E and activated (value `trEL` > turn-on time of switch, e.g. 5.0s), the triggering time is measured automatically. The measurement voltage has to be connected and no alarm is allowed to be present (K1 and K2 picked up)! During the test an active `Err1` is repressed. This allows troubleshooting for minimum 3 minutes.

#### Start test:

Select circuit K1 (`t5t1`) or K2 (`t5t2`) by pressing the buttons Up / Down. The test starts, after pressing the button Set and the selected relay is switched off. If the feedback contact is connected (Y1 or Y2), the tripping time of internal relay + switch is displayed for 3 minutes or until the button test is pressed.

Without connected / activated feedback contacts, `noY1` or `noY2` is displayed.

To exit the test-menu, wait for 3 minutes without a button or select `End` by pressing the buttons Up / Down and confirm by pressing the button Set.

### 9.13 Alarm counter

The alarm counter `Rc` is increased by 1 with every shut-down. Up to 100 shut-downs are counted. That allows quick detection of how often the UFR1001E has shut down since the last delete of the alarm counter (see cumulative alarm time).

Query the alarm counter:

- |  |
|--|
| <ul style="list-style-type: none"><li>• Change into the display mode</li></ul>   |
| <ul style="list-style-type: none"><li>• Press the  button several times until → display <code>Rcxx</code></li></ul> |



### 9.14 Cumulative alarm time (display in hours)

The cumulative alarm time `tRL` indicates how long the relay was switched off due to an alarm. It is recorded with a resolution of 1 minute and only when the control voltage is applied.

Query the cumulative alarm time:

- |  |
|--|
| <ul style="list-style-type: none"><li>• Change into the display mode</li></ul>   |
| <ul style="list-style-type: none"><li>• Press the  button several times until → display <code>Rcxx</code></li></ul>   |
| <ul style="list-style-type: none"><li>• Press the  button 1x → display <code>tRL</code> / <code>x.xx</code></li></ul> |



Delete the alarm counter and cumulative alarm time (only together):

- |   |
|---|
| <ul style="list-style-type: none"><li>• Display alarm counter <code>Rcxx</code></li></ul>   |
| <ul style="list-style-type: none"><li>• Press the  button 1x → display <code>tRL</code> / <code>x.xx</code></li></ul>                  |
| <ul style="list-style-type: none"><li>• Keep the  button pressed for 2s until → display <code>tRL</code> / <code>0.00</code></li></ul> |

## 9.15 Alarm memory

Independent of the alarm counter, the UFR1001E stores the most recent 100 shut-down causes (cause, measurement value, at operating time). Simulated alarms are also registered. The LEDs indicate the cause; the tripping value that led to the alarm each stands in the 7-segment display. Alternative to that the time is shown in hours which have passed since the last tripping (with applied control voltage). These values remain saved even after the power has been turned off.

Query alarm memory:

• Change into the display mode
• Press the  button several times → display <b>RcXX</b>
• Press the  button 1x → display <b>xXX / xXX</b> (tripping value or error no. / time that has passed in hours)
• Press the  button 1x, go to next alarm

The alarm memory is only deleted during a program change.

## 9.16 Standby counter and standby time



The standby counter **StbY**, is increased by 1 with every standby shut-down. Up to 9999 shut-downs are counted. That lets the UFR1001E quickly detect how often, e.g., shut-down was performed through a ripple control receiver.

Query the standby counter:



• Change into the display mode
• Press the  button several times until → display <b>RcXX</b>
• Press the  button 2x → display <b>StbY / xxxX</b>

The standby time **StbY** indicates how long the relay was switched off by the standby mode. It is recorded with a resolution of 1 minute and only when the control voltage is applied and if no alarm is present.

Query the standby time:

• Change into the display mode
• Press the  button several times until → display <b>RcXX</b>
• Press the  button 3x → display <b>StbY / x.XX</b> (Time LED is illuminated)

Delete the standby counter and standby time (only together):









• Display alarm counter <b>RcXX</b>
• Press the  button 2x → display <b>StbY / xxxX</b>
• Keep the  button pressed for 2s until → display <b>StbY / 0</b>

## 9.17 Code lock

You can protect the set parameters by enabling the code lock here.

The device acknowledges an incorrect entry with **Err** (flashes three times).

Adjustment process:

• Select the menu item with the   buttons until → display <b>Code</b>
• Press the  button 1x → display <b>Pin / 0</b>
• Set the <b>saved</b> pin code with the   buttons ( <b>default setting is 504</b> )
• Press the  button 1x → display <b>Code / oFF</b>
• Use the   buttons to set the desired code lock: <ul style="list-style-type: none"><li>○ <b>oFF</b> off, all parameters can be changed</li><li>○ <b>oN</b> on, no parameters can be changed</li></ul>
• Press the  button 1x → display <b>Pin / 504</b>

<ul style="list-style-type: none"> <li>Use the ▲▼ buttons to set the new, desired pin code (<b>caution: write down the pin code</b>)</li> </ul>
<ul style="list-style-type: none"> <li>Press the ▶ button 1x</li> </ul>
<ul style="list-style-type: none"> <li>⇒ Code lock on, display on flashes three times</li> <li>⇒ Code lock off, display oFF flashes three times</li> </ul>
<ul style="list-style-type: none"> <li>⇒ Return to menu mode, menu item code lock</li> </ul>

If there are any problems with the code lock (pin forgotten), the lock can be switched off and the pin can be reset to 504 by keeping the Set key pressed while switching on the mains until ▶ [odE / oFF appears in the display.

### 9.18 Sealing

All the settings and the simulation mode can be locked.

If the  LED is illuminated, the UFR1001E is locked.

If an attempt is made to change a setting in the locked state, for 3s the display shows Loc .

Adjustment procedure Sealing/Lock ON (OFF):

<ul style="list-style-type: none"> <li>If present, remove seal (only authorised person)</li> </ul>
<ul style="list-style-type: none"> <li>Apply control supply voltage at A1-A2</li> </ul>
<ul style="list-style-type: none"> <li>Slightly lift the key cover and turn 180°</li> </ul>
<ul style="list-style-type: none"> <li>Actuate the small blue button by <u>pressing the button cover very firmly</u> (LED starts flashing) until the green LED  is illuminated.</li> </ul>

### 9.19 Simulation

Here, the voltage, frequency or a vector surge can be simulated and the setting can be tested. All 3 phases plus the 10 minute mean value are always simulated. All functions of the device operate as if this value is actually being measured. Alarm and error messages are only indicated with the LEDs and not in the display. The set values are simulated until the menu item S<sub>i</sub> . is exited with the ▲ or ▼ button. If the UFR1001E is sealed/locked, simulation is not possible.

If the section switch feedback contacts are connected to the UFR1001E and enabled, (set value > section-switch turn-on time under t<sub>REL</sub> ), after a shut-down, the tripping time (dAL + time of slowest section switch) is displayed.

Adjustment process:

<ul style="list-style-type: none"> <li>Select the menu item with the ▲▼ buttons until → display S<sub>i</sub> .</li> </ul>
<ul style="list-style-type: none"> <li>Press the ▶ button 1x → display S<sub>i</sub> / U</li> </ul>
<ul style="list-style-type: none"> <li>Use the ▲▼ buttons to set the measurement factor for simulation: <ul style="list-style-type: none"> <li>○ U Voltage + 10min mean value (frequency = last simulated value)</li> <li>○ F Frequency (voltage = last simulated value)</li> <li>○ uS<sub>r</sub> Vector shift</li> </ul> </li> </ul>
<ul style="list-style-type: none"> <li>Press the ▶ button 1x → display 230 (selected measurement factor is simulated)</li> </ul>
<ul style="list-style-type: none"> <li>Use the ▲▼ buttons to set the desired value</li> </ul>

After exiting the Simulation menu item with the ▲▼ buttons, the unit switches over to monitoring the limits. The unit automatically returns to the display mode if no button is pressed for 15 minutes.

**Hint:** A limit value should be tested that is higher than the set 10min mean value. If the 10min mean value has to be temporarily switched off, set ( U<sub>n</sub> . → oFF. since otherwise it will trip first. The same applies, for example, for U<sup>-</sup> , during a simulation of U<sup>-</sup> in Pr3 and Pr4. (Medium voltage)

## 9.20 Possible indications in display

### Display mode

AL , AN , ALUD	Alarm , Alarm 10min mean value, Alarm zero voltage $U_0$
Err4 ... Err9	Error messages (see <a href="#">Error messages and measures</a> )
Ac , tAL , StbY	Alarm counter, cumulative alarm time, Standby counter/Standby time (LED Time on)
Scn , n	Scan mode, 10min mean value

### Menu mode / configuration mode

U <sup>-</sup> , U <sup>-</sup> , U <sub>-</sub> , U <sub>-</sub>	Voltage limit value
UN	Limit value 10min mean value
H <sup>-</sup> , H <sup>-</sup> , H <sub>-</sub> , H <sub>-</sub> , HN	Hysteresis (if a limit value is changed, the reset value also shifts; that means it might be necessary to adapt it)
F <sup>-</sup> , F <sup>-</sup> , F <sub>-</sub> , F <sub>-</sub> , dFdt	Frequency limit value, ROCOF (df/dt) limit value
dAL	Response time
doF , doFA	Reset time; is always counted down in the display
ind , ALL	Turn-on time adjust individual / all together (e.g. for Testing)
uSr	Vector surge
SbY5 , SbY0	Standby switch on terminals E1-E2: N/O contact / N/C contact
StbY	Standby mode, standby-time, standby-counter
Y1Y2	Evaluation of the feedback contacts is suppressed when E1-E2 are closed
dEon	Delay Enable On, suppression time when switching on and after opening the enable input
1 Ph , 3 Ph	Single phase, three-phase vector shift evaluation
rocF , PEr	ROCOF (df/dt), Periods
rEL	Relay
t <sub>r</sub> EL	Section switch turn-on time, OFF no feedback contacts
ddi	Delay display, to calm down the display
di t	Display duration scan mode (each measurement is displayed for this duration)
S <sub>i</sub> , F , U	Simulation, Frequency, voltage
CoDE , PL0 , uSr	Code lock / sealing, vector shift
Pin , InFo	Pin code (default 504), Device information, program change
Fnr , Snr	Firmware version, serial number
h	Operating hours
Err , dEL	Error counter, delete error counter
YES , no	Yes, no query for acknowledgement
Pr , on , OFF	Program, On, Off
UonF	Frequency protection off if voltage < UonF
tSt1 , tSt2 , noY1 , noY2 , End	Test mode: test relay K1, test relay K2, no response Y1, Y2 or monitoring feedback contacts not activated
rUEF	Function for testing disengaging ratio
UFon	Switch-on behaviour after off-limit condition
nFr	Narrower frequency window (narrower frequency range)
U <sub>-</sub> , HU <sub>-</sub> , 3U0 , H3U0	Menu nFr : Undervoltage and zero voltage $3U_0$ , with hysteresis
St <sub>r</sub> t , StU <sup>-</sup> , StU <sub>-</sub> , StF <sup>-</sup> , StF <sub>-</sub> , don ,	Starting conditions limits (and time delay)
At t	Restart attempts

## 10 Technical Data

<b>Control voltage Us:</b>	
Rated connection	AC/DC 24-270 V, 0/40...70 Hz, < 5 VA DC: 20.4...297 V, AC: 20.4...297 V
Bridging time at dropping Us	230 V → 0V: 400 ms
<b>Output relay:</b>	
Switching voltage	2 x change-over contact Max. AC 400 V
Conventional thermal current I <sub>th</sub>	6 A
Inrush current (at 10 % ED)	25 A max. 4 s / 50 A max. 1 s
Nominal operating current I <sub>e</sub> (AC 15)	I <sub>e</sub> = 6 A U <sub>e</sub> = 250 V
Rated operational current	DC-13 I <sub>e</sub> = 2 A U <sub>e</sub> = 24 V
Rated operational voltage	DC-13 I <sub>e</sub> = 0,4 A U <sub>e</sub> = 120 V DC-13 I <sub>e</sub> = 0,2 A U <sub>e</sub> = 240 V
Recommended series fuse	gG/gL/B 6 A
Contact service life, mech.	30 x 10 <sup>6</sup> switching cycles
Contact service life, electr.	1 x 10 <sup>6</sup> operating cycles at AC 250 V / 6 A 2 x 10 <sup>5</sup> operating cycles at AC 250V / 10A cos φ 0.6
Clearance and creepage distance K1-K2	≥ 3mm
<b>Voltage measurement:</b>	
Measurement voltage phase – phase	AC 15...530 V (< 5 V: 0 is displayed)
Adjustment range phase – phase	AC 15...520 V
Measurement voltage phase – N	AC 10...310 V (< 5 V: 0 is displayed)
Adjustment range phase – N	AC 15...300 V
Measurement principle	Real root mean square measurement both half waves
Hysteresis	Adjustable 1.0...180.0 V
Measurement error (with N)	± 0.6 % of the measurement value
Measurement error (without N)	± 0.8 % of the measurement value
Display accuracy	>100V: -1 digit (res. 1 V), <100V: -1 digit (res. 0.1V)
Measurement function	3-phase with/without N
Response time	Adjustable 0.05 (±15ms)... 300.0 s
Reset time	Adjustable 0(>200ms) ... 6000 s
Input resistance Phase-N	227 kΩ
disengaging ratio	< 2 % (at values > 20 V)
<b>Frequency measurement:</b>	
Frequency range	40...70 Hz
Adjustment range	45.00...65.00 Hz
Hysteresis	0.05...10.00 Hz
Measurement accuracy	± 0.04Hz ± 1 digit
Response time	Adjustable 0.05 (±15ms)...300.0 s
Reset time	Adjustable 0 (>200ms) ... 6000 s
Frequency undervoltage protection	off / 10,0...320 V
disengaging ratio	< 1 %
<b>Vector surge:</b>	
Measurement range	0...90.0°
Adjustment range	2.0...65.0°
Response time	< 50 ms
Reset time	Adjustable 3...240 s
Delay at Us on	Adjustable 2...20 s

Zero voltage:	
Measurement voltage phase – N	AC 0...310 V
Adjustment range phase – N	AC 1...300 V
Measurement principle	$U_0$ is calculated by $U_{Lx-N}$ and $\varphi_{Lx}$
Hysteresis	Adjustable 1.0...180.0 V
Measurement error (with N)	$\pm 1.8 \%$ of the measurement value
Display accuracy	>100V: -3 digit (res. 1 V), <100V: -3 digit (res. 0.1V)
Measurement function	3-phase with/without N
Response time	Adjustable 0.05 ( $\pm 15$ ms)... 300.0 s
Reset time	Adjustable 0(>200ms) ... 6000 s

Digital outputs:	
Switching voltage I1	(galvanic isolated) DC 4.5...27 V
Current Q1...Q5	Max 20 mA / output

ROCOF	
Frequency range	(df/dt) 40...70 Hz
Adjustment range	0,100...5,000 Hz/s, 4...50 Periods
Hysteresis	fixed 0,05Hz
Measurement error	$\pm 0,04$ Hz $\pm 1$ Digit
Response time	adjustable 0,05 ( $\pm 15$ ms) ... 130,0 s
Reset time	adjustable 0 (>200ms) ... 999 s
Measurement time	Number of adjusted Periods * Periods duration + Response time

Contactor feedback inputs	
Voltage / Current Y0 – Y1/2	DC 15...35 V / ca. 4mA
Voltage / Current E1 – E2	DC 15...35 V / ca. 6mA
Contactor response time (section switch)	Adjustable 0.5...99.0 s

Test conditions	
Rated impulse voltage	IEC/EN 60255 4000 V
Overvoltage category	III
Pollution degree	2
Rated insulation voltage $U_i$	300 V
Operating time	100 %
Operating temperature	-20 °C... +55 °C
Storage temperature	-25 °C ... +70 °C
Climatic conditions (IEC/EN 60721-3-3)	3K5 (except condensation and formation of ice)

Tests:	IEC/EN 60255-1		
Storage tests			
Dry heat	IEC 60068-2-2	+ 70 °C	16 h
Cold	IEC 60068-2-1	- 25 °C	16 h
Operational tests			
Dry heat	IEC 60068-2-2	+ 55 °C	16 h
Cold	IEC 60068-2-1	- 20 °C	16 h
Cyclic temperature	IEC 60068-2-14	- 25 °C / + 55 °C 5 cycle 3 + 3 h	
Damp heat steady state	IEC 60068-2-78	+ 40 °C	95 % RH 21 days
Cyclic temperature with humidity	IEC 60068-2-30	+25°C 97% RH/+55 °C 93% RH 6 cycle 12 + 12 h	
IEC 60255-21-1	vibration	class 1	
IEC 60255-21-2	shock	class 1	
IEC 60255-21-3	seismic test	class 1	
EMC - immunity	EN 61000-6-2		
EMC - emission	EN 61000-6-3		

Housing:	
Construction form	V6
Front-to-back size	55 mm
Dimensions (W x H x D)	90 x 105 x 69 mm
Wiring connection single strand	each 1 x 4mm <sup>2</sup>
Finely stranded with wire end ferrule	each 1 x 2.5mm <sup>2</sup>
Protection class, housing	IP 30
Protection class, terminals	IP 20
	Mounting snap-on fastening on 35 mm mounting rail acc EN 60 715 or with M4 screwed attachment (additional bar not included in the scope of delivery)
Weight	approx. 250 g

**We reserve the right to make technical changes**



## 11 Troubleshooting and measures

Error	Cause	Remedy
<b>EEEE</b> or <b>-EEE</b> appears in the display	Measurement is above/below range	Measured voltage, frequency or the vector surge is too large or too small; comply with measurement range
<b>Err4</b> appears in the display	Tolerance error, internal measurement value deviation of both channels	Perform a reset → interrupt control voltage for >5s *  In the case of Err5, check whether long cables are connected to terminals E or Y and/or whether they lead through an environment with interference.
<b>Err5</b> appears in the display	Error internal interface	
<b>Err6</b> appears in the display	Communication error, internal interface	
<b>Err7</b> appears in the display (possibly after automatic repeated trials of switching on), LED K1 and/or K2 is flashing	<u>Error feedback at Y1/Y2</u> <ul style="list-style-type: none"> <li>Contact of section switch not correctly connected</li> <li>Section switch faulty or controlled from another device</li> </ul>	<u>Feedback contacts not connected</u> - set <b>rEL</b> → <b>ErEL</b> → <b>oFF</b> <u>Feedback contacts connected</u> - check the correct connection - Perform a reset → press Set/Reset for >2 s
<b>Err8</b> appears in the display	Hysteresis error	Upper threshold value must be higher than the lower threshold value, check the threshold values
<b>Err9</b> appears in the display	Parameter error	Reset to factory settings, see "Program setup" *
A time expires in the display	Always when an OFF-delay time <b>doF</b> is running, it is counted down in the display (shortest one first)	Wait until the time has expired (depending on the setting, several times may elapse one after the other)
Device cannot be configured / only the limits can be configured	Code lock / Sealing activated	If there are any problems with the code lock (pin forgotten), the lock can be switched off and the pin can be reset to 504 by keeping the Set key pressed while switching on the mains until <b>CoDE</b> / <b>oFF</b> appears in the display.
Implausible voltage values	Pr selected with N, but N not connected	Select Pr without N or connect N
<b>Loc</b> appears in the display	Seal is active	See Sealing
<b>CoDE</b> appears in the display	Code lock is active	See „Code lock“
<b>StbY</b> appears in the display	Standby mode, E1-E2 active	Check parameter <b>u5r</b> .
<b>RL</b> and LED Q3 (f>) is on, reading in good range	hysteresis for <b>F<sup>-</sup></b> incorrectly	Check hysteresis for reset point >50 Hz
<b>noY1</b> or <b>noY2</b> appears in the display	Feedback contacts not connected or switch does not switch	Check the connection and function of the switch. Its normal in Pr2 at Test 2 <b>noY2</b> .

\* If the error cannot be patched by a reset, send back to factory for repair.



## 12 Maintenance and repair

The UFR1001E is maintenance-free. Periodically test for proper functioning.

## 13 Construction form V6

Dimensions in mm

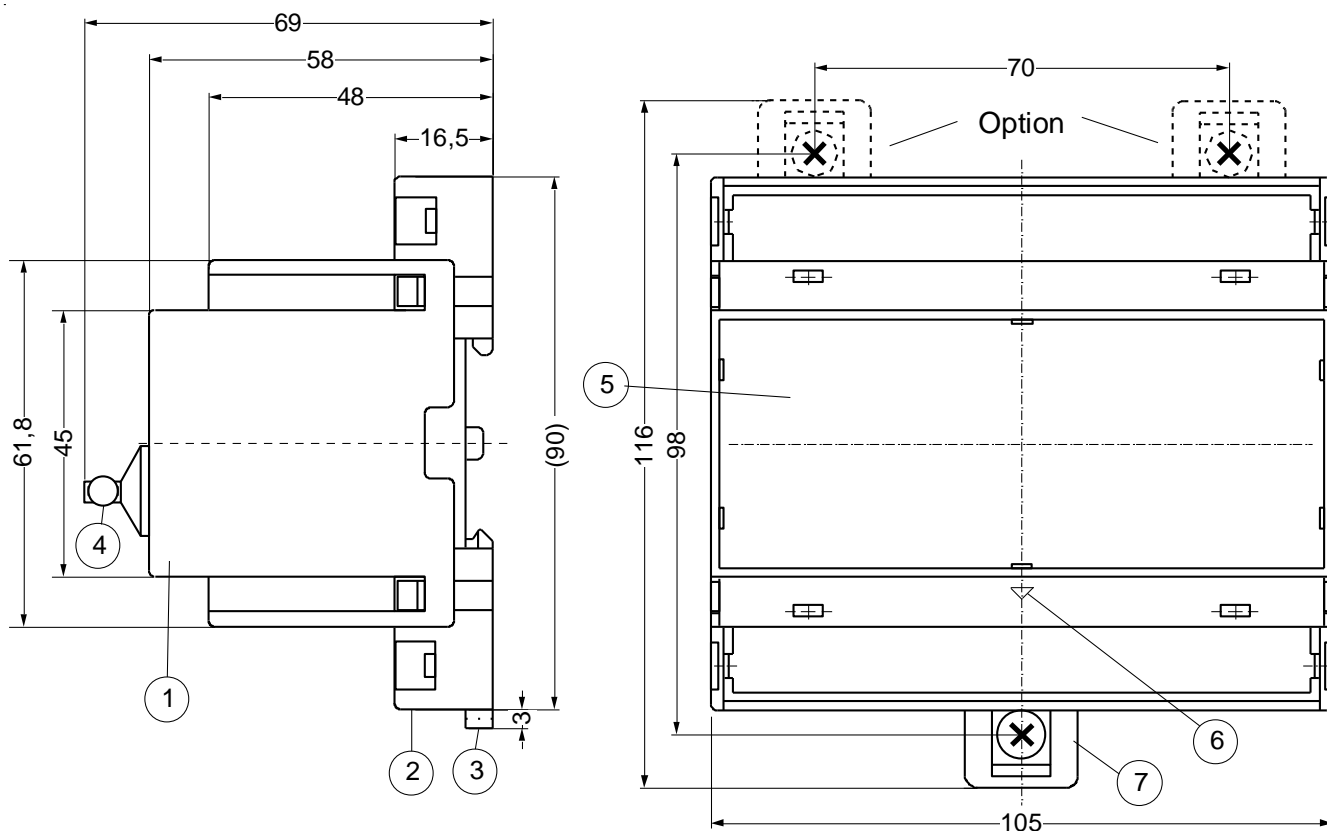

- 1 Oberteil / cover
- 2 Unterteil / base
- 3 Riegel / bar for snap mounting
- 4 Sealing max.  $\varnothing$  1.8 mm
- 5 Frontplatteneinsatz / front panel
- 6 Kennzeichen für unten / position downward
- 7 Bar for wall attachment with screws. Riegelbohrung  $\varnothing$  4,2 mm / Bolt hole for fixing to wall with screws,  $\varnothing$  4.2 mm.

## 14 Adjustment values table VDE-AR-N 4105:2011, Low Voltage Pr 1+7

Protective function	AR 4105	ZIEHL	in * Un	in % Un	Adjustment value	Tripping time dAL	OFF-delay time doF
Voltage decrease protection	U<	U <sub>-</sub>	0.8 * Un	80 % Un	184 V	100 ms	60 s
Voltage increase protection (10-minutes mean value)	U>	U <sub>n</sub>	1.1 * Un	110% Un	253V	100 ms	60 s
Voltage increase protection	U>>	U <sup>-</sup>	1.15 * Un	115% Un	264V	100 ms	60 s
Frequency decrease protection	f<	F <sub>-</sub>			47.5Hz	100 ms	60 s
Frequency increase protection	f>	F <sup>-</sup>			51.5Hz	100 ms	60 s
Switching conditions		UF <sub>on</sub>			off		
Starting conditions		St <sub>rt</sub>			off		

## 15 Adjustment values table BDEW June 2008, acc 3.2.3.3-1, Medium Voltage Pr 3-6

Function	BDEW	ZIEHL	Adjustment range of the protective relay	Default settings	
Voltage increase protection	U>>	U <sup>-</sup>	1.00 – 1.30 U <sub>n</sub>	1.15 U <sub>n</sub>	100 ms
Voltage increase protection	U>	U <sup>-</sup>	1.00 – 1.30 U <sub>n</sub>	1.08 U <sub>n</sub>	60 s
Voltage decrease protection	U<	U <sub>-</sub>	0.10 – 1.00 U <sub>n</sub>	0.80 U <sub>n</sub>	2.7 s
Voltage decrease protection *	U<<	U <sub>-</sub>	0.10 – 1.00 U <sub>n</sub>	0.45 U <sub>n</sub>	300 ms
Frequency increase protection	f>	F <sup>-</sup>	50.0 – 65.0 Hz	51.5Hz	100 ms
Frequency decrease protection	f<	F <sub>-</sub>	45.0 – 50.0 Hz	47.5Hz	100 ms
Switching conditions		UF <sub>on</sub>		off	
Starting conditions		St <sub>rt</sub>		off	

\* Not enabled in as delivered condition

## 16 Adjustment values table VDE-AR-N 4105:2018-11, Low Voltage 6. table 2, Pr 2

### Adjustment values for converters

Protective function	AR 4105	ZIEHL	in * Un	in % Un	Adjustment value	Tripping time dAL	OFF-delay time doF
Voltage increase protection	U>>	U <sup>-</sup>	1,25 * Un	125 % Un	287 V	100 ms	60 s
Voltage increase protection (10-minutes mean value)	U>	U <sub>n</sub>	1,1 * Un	110 % Un	253 V	100 ms	60 s
Voltage decrease protection	U<	U <sub>-</sub>	0,8 * Un	80 % Un	184 V	3,0 s	60 s
Voltage decrease protection	U<<	U <sub>-</sub>	0,45 * Un	45 % Un	103 V	300 ms	60 s
Frequency increase protection	f>	F <sup>-</sup>			51,5 Hz	100 ms	60 s
Frequency decrease protection	f<	F <sub>-</sub>			47,5 Hz	100 ms	60 s
Switching conditions		UF <sub>on</sub>			off		
Starting conditions		St <sub>rt</sub>			off		

## 17 Adjustment values (VDE-AR-N 4110:2018-11 Medium Voltage / VDE-AR-N 4120:2018-11 High Voltage) higher protection Pr 11+12

Acc. to 10.3.5.3 table 12, higher protection device

Funktion	AR 4110	ZIEHL	Adjustment range of the protective relay	Default settings	
Voltage increase protection	U>>	U <sup>+-</sup>	1,00 – 1,30 U <sub>n</sub>	1,2 U <sub>n</sub>	300 ms
Voltage increase protection	U>	U <sup>-</sup>	1,00 – 1,30 U <sub>n</sub>	1,1 U <sub>n</sub>	180 s
Voltage decrease protection	U<	U <sub>-</sub>	0,10 – 1,00 U <sub>n</sub>	0,80 U <sub>n</sub>	2,7 s
Frequency increase protection *	f>	F <sup>-</sup>	50,0 – 65,0 Hz	51,5 Hz	5,4 s
Frequency decrease protection *	f<	F <sub>-</sub>	45,0 – 50,0 Hz	47,5 Hz	400 ms
Switching conditions		UF <sub>on</sub>		off	
Starting conditions		St <sub>rt</sub>		off	

\* Not enabled in as delivered condition

## 18 Adjustment values VDE-AR-N 4110:2018-11, Medium Voltage Unit Protection Pr 13+14

Acc. to 10.3.5.3 table 13, protection at the generating units

Funktion	AR 4110	ZIEHL	Adjustment range of the protective relay	Default settings	
Voltage increase protection	U>>	U <sup>+-</sup>	1,00 – 1,30 U <sub>n</sub>	1,25 U <sub>n</sub>	100 ms
Voltage decrease protection	U<	U <sub>-</sub>	0,10 – 1,00 U <sub>n</sub>	0,80 U <sub>n</sub>	1,0 s
Voltage decrease protection	U<<	U <sub>--</sub>	0,10 – 1,00 U <sub>n</sub>	0,45 U <sub>n</sub>	300 ms
Frequency increase protection	f>>	F <sup>+-</sup>	50,0 – 65,0 Hz	52,5 Hz	100 ms
Frequency increase protection	f>	F <sup>-</sup>	50,0 – 65,0 Hz	51,5 Hz	5,0 s
Frequency decrease protection	f<	F <sub>-</sub>	45,0 – 50,0 Hz	47,5 Hz	100 ms
Switching conditions		UF <sub>on</sub>		on	
Starting conditions		St <sub>rt</sub>		on	

## 19 Disposal



Disposal should be carried out properly and in an environmentally friendly manner in accordance with legal provisions.

ZIEHL is registered with the EAR Foundation under WEEE no.: DE 49 698 543.



## 20 Default settings of the programs

### 20.1 VDE-AR-N 4105:2011+2018 + BDEW

When changing programs, all parameters are reset to the default settings.

Pr2 is pre-set at the factory  
(Code lock is active)

- Parameter can be changed without unlocking code lock
- Autohysteresis 50,05 Hz
- Autohysteresis 50,10 Hz

		 Germany VDE-AR-N4105:			 Germany BDEW				
		2011		2018	BDEW				
		3AC + 3AC+N 230 V	2/1 AC+N 230 V	3AC + 3AC+N 230 V	3AC+N 57,7 V	3AC 100 V	3AC+N 230 V	3AC 400 V	
Menu	Parameter	My Data	Pr1	Pr7	Pr2	Pr3	Pr4	Pr5	Pr6
59.S2 59>S2	U <sup>---</sup> Alarm on/off		oFF	oFF	on	on	on	on	on
	U <sup>---</sup> Overvoltage [V]		264	264	287	66.4	115	264	458
	H <sup>---</sup> Hysteresis [V]		5.0	5.0	35.0	1.0	1.0	3.0	3.0
	dRL response time [s]		0.10	0.10	0.10	0.10	0.10	0.10	0.10
	doF off-Delay [s]		60	60	60	60	60	60	60
59.S1 59>S1	U <sup>-</sup> Alarm on/off		on	on	oFF	on	on	on	on
	U <sup>-</sup> Overvoltage [V]		264	264	264	62.3	108	249	430
	H <sup>-</sup> Hysteresis [V]		5.0	5.0	12.0	1.0	1.0	3.0	3.0
	dRL response time [s]		0.10	0.10	0.10	60.0	60.0	60.0	60.0
	doF off-Delay [s]		60	60	60	60	60	60	60
59-Av	U <sup>∏-</sup> Alarm on/off		on	on	on	oFF	oFF	oFF	oFF
	U <sup>∏-</sup> Overvoltage [V]		253	253	253	63.5	110	253	438
	H <sup>∏-</sup> Hysteresis [V]		3.0	3.0	5.0	1.0	1.0	3.0	3.0
	dRL response time [s]		0.10	0.10	0.10	0.10	0.10	0.10	0.10
	doF off-Delay [s]		60	60	60	60	60	60	60
27.S1 27<S1	U <sub>-</sub> Alarm on/off		on	on	on	on	on	on	on
	U <sub>-</sub> Undervoltage [V]		184	184	184	46.2	80.0	184	318
	H <sub>-</sub> Hysteresis [V]		5.0	5.0	12.0	1.0	1.0	3.0	3.0
	dRL response time [s]		0.10	0.10	3.00	2.70	2.70	2.70	2.70
	doF off-Delay [s]		60	60	60	60	60	60	60
27.S2 27<S2	U <sub>--</sub> Alarm on/off		oFF	oFF	on	oFF	oFF	oFF	oFF
	U <sub>--</sub> Undervoltage [V]		184	184	103	26.0	45.0	104	180
	H <sub>--</sub> Hysteresis [V]		5.0	5.0	93.0	1.0	1.0	2.0	2.0
	dRL response time [s]		0.10	0.10	0.30	0.30	0.30	0.30	0.30
	doF off-Delay [s]		60	60	60	60	60	60	60
81.S2 81>S2	F <sup>---</sup> Alarm on/off		oFF	oFF	oFF	oFF	oFF	oFF	oFF
	F <sup>---</sup> Overfrequency [Hz]		5150	5150	5250	5150	5150	5150	5150
	H <sup>---</sup> Hysteresis [Hz]		1.45	1.45	2.40	1.45	1.45	1.45	1.45
	dRL response time [s]		0.10	0.10	0.10	0.10	0.10	0.10	0.10
	doF off-Delay [s]		60	60	60	60	60	60	60
81.S1 81>S1	F <sup>-</sup> Alarm on/off		on	on	on	on	on	on	on
	F <sup>-</sup> Overfrequency Hz		5150	5150	5150	5150	5150	5150	5150
	H <sup>-</sup> Hysteresis Hz		1.45	1.45	1.40	1.45	1.45	1.45	1.45
	dRL response time [s]		0.10	0.10	0.10	0.10	0.10	0.10	0.10
	doF off-Delay [s]		60	60	60	60	60	60	60
81.S1 81<S1	F <sub>-</sub> Alarm on/off		on	on	on	on	on	on	on
	F <sub>-</sub> Underfrequency [Hz]		47.50	47.50	47.50	47.50	47.50	47.50	47.50
	H <sub>-</sub> Hysteresis [Hz]		1.00	1.00	0.10	1.00	1.00	1.00	1.00
	dRL response time [s]		0.10	0.10	0.10	0.10	0.10	0.10	0.10
	doF off-Delay [s]		60	60	60	60	60	60	60
81.S2 81<S2	F <sub>--</sub> Alarm on/off		oFF	oFF	oFF	oFF	oFF	oFF	oFF
	F <sub>--</sub> Underfrequency [Hz]		47.50	47.50	47.00	47.50	47.50	47.50	47.50
	H <sub>--</sub> Hysteresis [Hz]		1.00	1.00	0.60	1.00	1.00	1.00	1.00
	dRL response time [s]		0.10	0.10	0.10	0.10	0.10	0.10	0.10
	doF off-Delay [s]		60	60	60	60	60	60	60

Display of the program:

Info → Pr

Display of the firmware version:

Info → Fnr

(or when switching on)

		Germany VDE-AR-N4105:			Germany			
		2011		2018	BDEW			
		3AC + 3AC+N 230 V	2/1 AC+N 230 V	3AC + 3AC+N 230 V	3AC+N 57,7 V	3AC 100 V	3AC+N 230 V	3AC 400 V
Menu	Parameter	Pr1	Pr7	Pr2	Pr3	Pr4	Pr5	Pr6
5trt	5trt Starting conditions	oFF	oFF	oFF	oFF	oFF	oFF	oFF
	5tU <sup>-</sup> Overvoltage [V]	259	259	253	6 13	107	246	427
	5tU <sub>-</sub> Undervoltage [V]	189	189	196	47.2	8 10	187	32 1
	5tF <sup>-</sup> Overfrequency [Hz]	50.05	50.05	50. 10	50.05	50.05	50.05	50.05
	5tF <sub>-</sub> Underfrequency [Hz]	48.50	48.50	47.60	48.50	48.50	48.50	48.50
	don Switch-on time [s]	60	60	60	60	60	60	60
nFr	nFr Alarm on/off	oFF	oFF	oFF	oFF	oFF	oFF	oFF
	U <sub>-</sub> Undervoltage [V]	196	196	196	49.0	85.0	196	339
	HU <sub>-</sub> Hysteresis U <sub>-</sub> [V]	3.0	3.0	3.0	3.0	3.0	3.0	3.0
	3U0 3U0 voltage [V]	1 15	1 15	1 15	1 15	1 15	1 15	1 15
	H3U0 Hysteresis 3U0 [V]	1.0	1.0	1.0	1.0	1.0	1.0	1.0
	dRL Response time [s]	0.05	0.05	0.05	0.05	0.05	0.05	0.05
	doF Off-delay [s]	60	60	60	60	60	60	60
UFon	UFon switching conditions	oFF	oFF	oFF	oFF	oFF	oFF	oFF
UonF	UonF on/off	oFF	oFF	oFF	oFF	oFF	oFF	oFF
	UonF voltage [V]	46.0	46.0	46.0	20.0	20.0	46.0	46.0
78	u5r Alarm on/off	5b95	5b95	5b95	5b95	5b95	5b95	5b95
	u5r Vector shift [°]	10.0	10.0	10.0	10.0	10.0	10.0	10.0
	doF off delay [s]	3	3	3	3	3	3	3
	dEon Suppression time [s]	2	2	2	3	3	3	3
	U5r Number of phases	3Ph	3Ph	3Ph	3Ph	3Ph	3Ph	3Ph
81r	rocF Alarm on/off	oFF	oFF	oFF	oFF	oFF	oFF	oFF
	dFdt delta f / delta t [Hz/s]	0.800	0.800	2.000	0.800	0.800	0.800	0.800
	PEr periods	20	20	20	20	20	20	20
	dRL response time [s]	0. 10	0. 10	0. 10	0. 10	0. 10	0. 10	0. 10
	doF off delay [s]	60	60	60	60	60	60	60
59v0	U-0 Alarm on/off	oFF	oFF	oFF	oFF	oFF	oFF	oFF
	U-0 Zero voltage [V]	46.0	46.0	46.0	46.0	80.0	46.0	80.0
	H-0 Hysteresis [V]	10.0	10.0	10.0	10.0	10.0	10.0	10.0
	dRL Response time [s]	1.50	1.50	1.50	1.50	1.50	1.50	1.50
	doF off-delay [s]	60	60	60	60	60	60	60
rEL	ErEL Response time Y1, Y2 [s]	5.0	5.0	5.0	oFF	oFF	oFF	oFF
	RtE reclosing attempts	2	2	2	2	2	2	2
	doFA mode	1 nd	1 nd	1 nd	1 nd	1 nd	1 nd	1 nd
	doFA off-delay All [s]	0	0	0	0	0	0	0
ddi	ddi Display Delay [s]	0.5	0.5	0.5	0.5	0.5	0.5	0.5
	di t Display Duration 5Cn [s]	3.5	3.5	3.5	3.5	3.5	3.5	3.5
Si	U Voltage [V]	230	230	230	57.7	100	230	400
	F Frequency [Hz]	50.00	50.00	50.00	50.00	50.00	50.00	50.00
	U5r Vector shift [°]	0.0	0.0	0.0	0.0	0.0	0.0	0.0
CodE	Pin Pincode	504	504	504	504	504	504	504
	CodE on/off	oFF	oFF	on	oFF	oFF	oFF	oFF
Info	Fnr Firmware version	0-38	0-38	0-38	0-38	0-38	0-38	0-38
	Snr Serial number	xxx	xxx	xxx	xxx	xxx	xxx	xxx
	h operating hours [h]	xxx	xxx	xxx	xxx	xxx	xxx	xxx
	Err Error Counter	xxx	xxx	xxx	xxx	xxx	xxx	xxx
	Pr Program	1	7	2	3	4	5	6

## 20.2 VDE-AR-N 4110:2018-11 + VDE-AR-N 4120:2018-11

When changing programs, all parameters are reset to the default settings.

- Parameter can be changed without unlocking code lock
- Autohysteresis 50,10 Hz
- Autohysteresis 49,90 Hz

		 Germany VDE-AR-N4110:2018 + VED-AR-N4120:2018				
		My	3AC+N	3AC	3AC+N	3AC
		Data	57,7 V	100 V	230 V	400 V
Menu	Parameter		Pr11	Pr12	Pr13	Pr14
U <sup>^^</sup> 59.S2 59>S2	U <sup>^^</sup> Alarm on/off		on	on	on	on
	U <sup>^^</sup> Overvoltage [V]		69.2	120	287	498
	H <sup>^^</sup> Hysteresis [V]		1.0	1.0	3.0	3.0
	dRL response time [s]		0.30	0.30	0.10	0.10
	dof off-Delay [s]		60	60	60	60
U <sup>-</sup> 59.S1 59>S1	U <sup>-</sup> Alarm on/off		on	on	oFF	oFF
	U <sup>-</sup> Overvoltage [V]		63.5	110	249	430
	H <sup>-</sup> Hysteresis [V]		1.0	1.0	3.0	3.0
	dRL response time [s]		180.0	180.0	60.0	60.0
	dof off-Delay [s]		60	60	60	60
UN <sup>-</sup> 59-Av	UN <sup>-</sup> Alarm on/off		oFF	oFF	oFF	oFF
	UN <sup>-</sup> Overvoltage [V]		63.5	110	253	438
	HN <sup>-</sup> Hysteresis [V]		1.0	1.0	3.0	3.0
	dRL response time [s]		0.10	0.10	0.10	0.10
	dof off-Delay [s]		60	60	60	60
U <sub>-</sub> 27.S1 27<S1	U <sub>-</sub> Alarm on/off		on	on	on	on
	U <sub>-</sub> Undervoltage [V]		46.2	80.0	184	318
	H <sub>-</sub> Hysteresis [V]		9.0	15.5	35.0	61.0
	dRL response time [s]		2.70	2.70	1.00	1.00
	dof off-Delay [s]		60	60	60	60
U <sub>--</sub> 27.S2 27<S2	U <sub>--</sub> Alarm on/off		oFF	oFF	on	on
	U <sub>--</sub> Undervoltage [V]		26.0	45.0	104	179
	H <sub>--</sub> Hysteresis [V]		29.0	50.0	115.0	180.0
	dRL response time [s]		0.30	0.30	0.30	0.30
	dof off-Delay [s]		60	60	60	60
F <sup>^^</sup> 81.S2 81>S2	F <sup>^^</sup> Alarm on/off		oFF	oFF	on	on
	F <sup>^^</sup> Overfrequency [Hz]		51.50	51.50	52.50	52.50
	H <sup>^^</sup> Hysteresis [Hz]		1.40	1.40	2.40	2.40
	dRL response time [s]		0.10	0.10	0.10	0.10
	dof off-Delay [s]		60	60	60	60
F <sup>-</sup> 81.S1 81>S1	F <sup>-</sup> Alarm on/off		oFF	oFF	on	on
	F <sup>-</sup> Overfrequency Hz		51.50	51.50	51.50	51.50
	H <sup>-</sup> Hysteresis Hz		1.40	1.40	1.40	1.40
	dRL response time [s]		5.40	5.40	5.00	5.00
	dof off-Delay [s]		60	60	60	60
F <sub>-</sub> 81.S1 81<S1	F <sub>-</sub> Alarm on/off		oFF	oFF	on	on
	F <sub>-</sub> Underfrequency [Hz]		47.50	47.50	47.50	47.50
	H <sub>-</sub> Hysteresis [Hz]		2.40	2.40	2.40	2.40
	dRL response time [s]		0.40	0.40	0.10	0.10
	dof off-Delay [s]		60	60	60	60
F <sub>--</sub> 81.S2 81<S2	F <sub>--</sub> Alarm on/off		oFF	oFF	oFF	oFF
	F <sub>--</sub> Underfrequency [Hz]		47.50	47.50	47.50	47.50
	H <sub>--</sub> Hysteresis [Hz]		2.40	2.40	2.40	2.40
	dRL response time [s]		0.10	0.10	0.10	0.10
	dof off-Delay [s]		60	60	60	60

Display of the program:

Info → Pr

Display of the firmware version:

Info → Fnr

(or when switching on)







Germany  
 VDE-AR-N4110:2018 +  
 VED-AR-N4120:2018

Menu	Parameter	My Data	3AC+N	3AC	3AC+N	3AC
			57,7 V	100 V	230 V	400 V
			Pr11	Pr12	Pr13	Pr14
5trt	5trt Starting conditions		oFF	oFF	on	on
	5tU <sup>-</sup> Overvoltage [V]		63.5	110	253	440
	5tU <sub>-</sub> Undervoltage [V]		51.9	90.0	207	360
	5tF <sup>-</sup> Overfrequency [Hz]		50.20	50.20	50.20	50.20
	5tF <sub>-</sub> Underfrequency [Hz]		47.50	47.50	47.50	47.50
	don Switch-on time [s]		60	60	60	60
nFr	nFr Alarm on/off		oFF	oFF	oFF	oFF
	U <sub>-</sub> Undervoltage [V]		49.0	85.0	196	339
	HU <sub>-</sub> Hysteresis U <sub>-</sub> [V]		3.0	3.0	3.0	3.0
	3U0 3U0 voltage [V]		11.5	11.5	11.5	11.5
	H3U0 Hysteresis 3U0 [V]		1.0	1.0	1.0	1.0
	dRL Response time [s]		0.05	0.05	0.05	0.05
	doF Off-delay [s]		60	60	60	60
UFon	UFon switching conditions		oFF	oFF	on	on
UonF	UonF on/off		oFF	oFF	oFF	oFF
	UonF voltage [V]		20.0	20.0	46.0	46.0
78	u5r Alarm on/off		5b95	5b95	5b95	5b95
	u5r Vector shift [°]		10.0	10.0	10.0	10.0
	doF off delay [s]		3	3	3	3
	dEon Suppression time [s]		3	3	3	3
	U5r Number of phases		3Ph	3Ph	3Ph	3Ph
81r	rocF Alarm on/off		oFF	oFF	oFF	oFF
	dFdt delta f / delta t [Hz/s]		2.000	2.000	2.000	2.000
	PEr periods		20	20	20	20
	dRL response time [s]		0.10	0.10	0.10	0.10
	doF off delay [s]		60	60	60	60
59v0	U-0 Alarm on/off		oFF	oFF	oFF	oFF
	U-0 Zero voltage [V]		46.0	80.0	46.0	80.0
	H-0 Hysteresis [V]		10.0	10.0	10.0	10.0
	dRL Response time [s]		1.50	1.50	1.50	1.50
	doF off-delay [s]		60	60	60	60
rEL	ErEL Response time Y1, Y2 [s]		oFF	oFF	oFF	oFF
	RtE reclosing attempts		2	2	2	2
	doFR mode		1nd	1nd	1nd	1nd
	doFR off-delay All [s]		0	0	0	0
ddi	ddi Display Delay [s]		0.5	0.5	0.5	0.5
	di t Display Duration 5Cn [s]		3.5	3.5	3.5	3.5
5i	U Voltage [V]		57.7	100	230	400
	F Frequency [Hz]		50.00	50.00	50.00	50.00
	U5r Vector shift [°]		0.0	0.0	0.0	0.0
CodE	Pin Pincode		504	504	504	504
	CodE on/off		oFF	oFF	oFF	oFF
Info	Fnr Firmware version		0-38	0-38	0-38	0-38
	Snr Serial number		xxx	xxx	xxx	xxx
	h operating hours [h]		xxx	xxx	xxx	xxx
	Err Error Counter		xxx	xxx	xxx	xxx
	Pr Program		11	12	13	14

## 20.3 TOR Erzeuger Typ A,B,C,D + NA/EEA-NE7 CH 2020 + C10/C11 + G98(G83/2)+G99(G59/3)

When changing programs, all parameters are reset to the default settings.

- Parameter can be changed without unlocking code lock
- Autohysteresis 50,05 Hz
- Autohysteresis 50,10 Hz

									
			Austria TOR Erzeuger A-D**	Switzerland NE/EEA NE7 CH2020 3AC + 3AC+N	Belgium C10/11 3AC+N	United Kingdom G98 (G83/2) + G99 (G59/3) 3/2/1 3AC+N 3AC 3AC+N 3AC			
			3AC+N 230 V	3AC+N 230 V	3AC+N 230 V	3AC+N 230 V	400 V	63,5 V	110 V
Menu	Parameter	My Data	Pr10	Pr15	Pr16	Pr20	Pr21	Pr22	Pr23
59.S2 59>S2	U <sup>^^</sup> Alarm on/off		on	on	on	on	on	on	on
	U <sup>^^</sup> Overvoltage [V]		264	276	264	273	476	717	124
	H <sup>^^</sup> Hysteresis [V]		13.3	23.0	5.0	5.0	5.0	1.0	1.0
	dRL response time [s]		0.10	0.10	0.05	0.50	0.50	0.50	0.50
	doF off-Delay [s]		60	60	1	20	20	20	20
59.S1 59>S1	U <sup>-</sup> Alarm on/off		oFF	oFF	on	on	on	on	on
	U <sup>-</sup> Overvoltage [V]		255	253	253	262	456	69.8	121
	H <sup>-</sup> Hysteresis [V]		4.3	3.0	5.0	5.0	5.0	1.0	1.0
	dRL response time [s]		60.0	60.0	1.00	1.00	1.00	1.00	1.00
	doF off-Delay [s]		60	60	1	20	20	20	20
59-Av	U <sup>∏</sup> Alarm on/off		on	on	oFF	oFF	oFF	oFF	oFF
	U <sup>∏</sup> Overvoltage [V]		255	253	253	262	456	65.8	121
	H <sup>∏</sup> Hysteresis [V]		4.3	3.0	5.0	5.0	5.0	1.0	1.0
	dRL response time [s]		0.10	0.10	1.00	1.00	1.00	1.00	1.00
	doF off-Delay [s]		60	60	1	20	20	20	20
27.S1 27<S1	U <sub>-</sub> Alarm on/off		on	on	on	oFF	oFF	oFF	oFF
	U <sub>-</sub> Undervoltage [V]		184	184	161	200	348	50.2	95.7
	H <sub>-</sub> Hysteresis [V]		11.5	12.0	5.0	5.0	5.0	1.0	1.0
	dRL response time [s]		1.00	1.50	1.50	2.50	2.50	2.50	2.50
	doF off-Delay [s]		60	60	1	20	20	20	20
27.S2 27<S2	U <sub>..</sub> Alarm on/off		on	on	on	on	on	on	on
	U <sub>..</sub> Undervoltage [V]		69.0	104	57.0	184	320	50.8	88.0
	H <sub>..</sub> Hysteresis [V]		126.5	92.0	5.0	5.0	5.0	1.0	1.0
	dRL response time [s]		0.20	0.30	0.05	2.50	2.50	2.50	2.50
	doF off-Delay [s]		60	60	1	20	20	20	20
81.S2 81>S2	F <sup>^^</sup> Alarm on/off		oFF	oFF	oFF	on	on	on	on
	F <sup>^^</sup> Overfrequency [Hz]		51.50	51.50	50.30	52.00	52.00	52.00	52.00
	H <sup>^^</sup> Hysteresis [Hz]		1.40	1.40	0.20	1.95	1.95	1.95	1.95
	dRL response time [s]		0.10	0.10	0.05	0.50	0.50	0.50	0.50
	doF off-Delay [s]		60	60	1	20	20	20	20
81.S1 81>S1	F <sup>-</sup> Alarm on/off		on	on	on	oFF	oFF	oFF	oFF
	F <sup>-</sup> Overfrequency Hz		51.50	51.50	51.50	51.50	51.50	51.50	51.50
	H <sup>-</sup> Hysteresis Hz		1.40	1.40	1.40	1.45	1.45	1.45	1.45
	dRL response time [s]		0.10	0.10	0.05	90.0	90.0	90.0	90.0
	doF off-Delay [s]		60	60	1	20	20	20	20
81.S1 81<S1	F <sub>-</sub> Alarm on/off		on	on	on	on	on	on	on
	F <sub>-</sub> Underfrequency [Hz]		47.50	47.50	47.50	47.50	47.50	47.50	47.50
	H <sub>-</sub> Hysteresis [Hz]		0.10	0.10	2.40	1.00	1.00	1.00	1.00
	dRL response time [s]		0.10	0.10	0.05	20.0	20.0	20.0	20.0
	doF off-Delay [s]		60	60	1	20	20	20	20
81.S2 81<S2	F <sub>..</sub> Alarm on/off		oFF	oFF	oFF	on	on	on	on
	F <sub>..</sub> Underfrequency [Hz]		47.50	47.50	49.70	47.00	47.00	47.00	47.00
	H <sub>..</sub> Hysteresis [Hz]		0.10	0.10	0.20	1.00	1.00	1.00	1.00
	dRL response time [s]		0.10	0.10	0.05	0.50	0.50	0.50	0.50
	doF off-Delay [s]		60	60	1	20	20	20	20







Display of the program:

Inf0 → Pr

Display of the firmware version:

Inf0 → Fnr





(or when switching on)

		 Austria TOR Erzeuger A-D**	 Switzerland NE/EEA NE7 CH2020 3AC + 3AC+N	 Belgium C10/11 3AC+N	 United Kingdom G98 (G83/2) + G99 (G59/3) 3/2/1 3AC+N 3AC 3AC+N 3AC				
			230 V	230 V	230 V	230 V	400 V	63,5 V	110 V
		My Data	Pr10	Pr15	Pr16	Pr20	Pr21	Pr22	Pr23
StE	StE Starting conditions		oFF	oFF	oFF	oFF	oFF	oFF	oFF
	StU <sup>-</sup> Overvoltage [V]		25 I	253	248	257	44 I	688	120
	StU <sub>-</sub> Undervoltage [V]		196	196	166	189	325	5 I8	89.0
	StF <sup>-</sup> Overfrequency [Hz]		50.10	50.10	50.10	50.05	50.05	50.05	50.05
	StF <sub>-</sub> Underfrequency [Hz]		47.60	47.60	49.90	48.50	48.50	48.50	48.50
	don Switch-on time [s]		60	60	1	20	20	20	20
nFr	nFr Alarm on/off		oFF	oFF	oFF	oFF	oFF	oFF	oFF
	U <sub>-</sub> Undervoltage [V]		196	196	196	196	339	54.0	94.0
	HU <sub>-</sub> Hysteresis U <sub>-</sub> [V]		3.0	3.0	3.0	3.0	3.0	3.0	3.0
	3U0 3U0 voltage [V]		115	115	115	115	115	115	115
	H3U0 Hysteresis 3U0 [V]		1.0	1.0	1.0	1.0	1.0	1.0	1.0
	dRL Response time [s]		0.05	0.05	0.05	0.05	0.05	0.05	0.05
	doF Off-delay [s]		60	60	1	20	20	20	20
UFon	UFon switching conditions		on	oFF	oFF	oFF	oFF	oFF	oFF
UonF	UonF on/off		oFF	oFF	oFF	oFF	oFF	oFF	oFF
	UonF voltage [V]		46.0	16 I	20.0	46.0	46.0	20.0	20.0
78	u5r Alarm on/off		5b95	5b95	oFF	5b95	5b95	5b95	5b95
	u5r Vector shift [°]		10.0	10.0	7.0	50.0	50.0	50.0	50.0
	doF off delay [s]		60	3	20	20	20	20	20
	dEon Suppression time [s]		2	2	2	2	2	2	2
	U5r Number of phases		3Ph	3Ph	3Ph	1Ph	1Ph	1Ph	1Ph
81r	rocF Alarm on/off		oFF	oFF	on	on	on	on	on
	dFdE delta f / delta t [Hz/s]		0.800	2.000	1.000	1.000	1.000	1.000	1.000
	PEr periods		20	20	8	20	20	20	20
	dRL response time [s]		0.10	0.10	0.20	0.50	0.50	0.50	0.50
	doF off delay [s]		60	60	1	20	20	20	20
59v0	U-0 Alarm on/off		oFF	oFF	oFF	oFF	oFF	oFF	oFF
	U-0 Zero voltage [V]		46.0	46.0	46.0	46.0	80.0	46.0	80.0
	H-0 Hysteresis [V]		10.0	10.0	10.0	10.0	10.0	10.0	10.0
	dRL Response time [s]		1.50	1.50	1.50	1.50	1.50	1.50	1.50
	doF off-delay [s]		60	60	1	60	60	60	60
rEL	ErEL Response time Y1, Y2 [s]		oFF	5.0	oFF	oFF	oFF	oFF	oFF
	RtE reclosing attempts		2	2	2	2	2	2	2
	doFR mode		1nd	1nd	1nd	1nd	1nd	1nd	1nd
	doFR off-delay All [s]		0	0	0	0	0	0	0
ddi	ddi Display Delay [s]		0.5	0.5	0.5	0.5	0.5	0.5	0.5
	di t Display Duration 5Cn [s]		3.5	3.5	3.5	3.5	3.5	3.5	3.5
Si	U Voltage [V]		230	230	230	230	400	63.5	110
	F Frequency [Hz]		50.00	50.00	50.00	50.00	50.00	50.00	50.00
	U5r Vector shift [°]		0.0	0.0	0.0	0.0	0.0	0.0	0.0
CodE	Pin Pincode		504	504	504	504	504	504	504
	CodE on/off		oFF	oFF	oFF	oFF	oFF	oFF	oFF
Inf0	Fnr Firmware version		0-38	0-38	0-38	0-38	0-38	0-38	0-38
	Snr Serial number		xxx	xxx	xxx	xxx	xxx	xxx	xxx
	h operating hours [h]		xxx	xxx	xxx	xxx	xxx	xxx	xxx
	Err Error Counter		xxx	xxx	xxx	xxx	xxx	xxx	xxx
	Pr Program		10	15	16	20	21	22	23

## 20.4 SFS-EN50549-1+2:2019 + EN50549-1 2-stage + NEN-EN50549-1:2019 + VDE 0126 VFR2019

When changing programs, all parameters are reset to the default settings.

- Parameter can be changed without unlocking code lock

		 Finland SFS-EN50549-1+2:2019		 Ireland EN50549-1 2-stage		 Netherlands NEN-EN50549-1:2019		 France VDE 0126 VFR2019	
		3AC+N 230 V	3AC 400 V	3AC+N 230 V	3AC 400 V	3AC+N 230 V	3AC+N 230 V	3AC+N 230 V	3AC+N 230 V
Menu	Parameter	My Data	Pr30	Pr31	Pr32	Pr33	Pr34	Pr36	
U <sup>^^</sup> 59.S2 59>S2	U <sup>^^</sup> Alarm on/off		oFF	oFF	on	on	on	on	
	U <sup>^^</sup> Overvoltage [V]		276	478	281	488	276	264	
	H <sup>^^</sup> Hysteresis [V]		23.0	40.0	5.0	5.0	23.0	3.0	
	dRL response time [s]		1.00	1.00	0.70	0.70	0.10	0.10	
	doF off-Delay [s]		60	60	20	20	60	60	
U <sup>-</sup> 59.S1 59>S1	U <sup>-</sup> Alarm on/off		on	on	on	on	oFF	oFF	
	U <sup>-</sup> Overvoltage [V]		276	478	269	468	253	249	
	H <sup>-</sup> Hysteresis [V]		23.0	40.0	5.0	5.0	3.0	3.0	
	dRL response time [s]		1.00	1.00	70.0	70.0	0.20	60.0	
	doF off-Delay [s]		60	60	20	20	60	60	
UN <sup>-</sup> 59-Av	UN <sup>-</sup> Alarm on/off		on	on	oFF	oFF	on	oFF	
	UN <sup>-</sup> Overvoltage [V]		253	438	262	456	253	253	
	HN <sup>-</sup> Hysteresis [V]		3.0	5.0	5.0	5.0	3.0	3.0	
	dRL response time [s]		0.10	0.10	1.00	70.0	0.20	0.10	
	doF off-Delay [s]		60	60	20	20	60	60	
U <sub>-</sub> 27.S1 27<S1	U <sub>-</sub> Alarm on/off		on	on	on	on	on	on	
	U <sub>-</sub> Undervoltage [V]		184	318	191	332	184	184	
	H <sub>-</sub> Hysteresis [V]		11.5	19.9	5.0	5.0	11.5	3.0	
	dRL response time [s]		1.50	1.50	0.70	0.70	3.00	2.70	
	doF off-Delay [s]		60	60	20	20	60	60	
U <sub>--</sub> 27.S2 27<S2	U <sub>--</sub> Alarm on/off		on	on	oFF	oFF	on	oFF	
	U <sub>--</sub> Undervoltage [V]		46.0	79.7	184	320	69.0	104	
	H <sub>--</sub> Hysteresis [V]		149.5	180.0	5.0	5.0	126.5	2.0	
	dRL response time [s]		0.25	0.25	2.50	2.50	0.10	0.30	
	doF off-Delay [s]		60	60	20	20	60	60	
F <sup>^^</sup> 81.S2 81>S2	F <sup>^^</sup> Alarm on/off		oFF	oFF	on	on	oFF	oFF	
	F <sup>^^</sup> Overfrequency [Hz]		51.50	51.50	52.10	52.10	51.50	51.50	
	H <sup>^^</sup> Hysteresis [Hz]		0.50	0.50	1.95	1.95	1.40	1.45	
	dRL response time [s]		0.20	0.20	0.50	0.50	0.10	0.10	
	doF off-Delay [s]		60	60	20	20	60	60	
F <sup>-</sup> 81.S1 81>S1	F <sup>-</sup> Alarm on/off		on	on	oFF	oFF	on	on	
	F <sup>-</sup> Overfrequency Hz		51.50	51.50	51.50	51.50	51.50	51.50	
	H <sup>-</sup> Hysteresis Hz		0.50	0.50	1.45	1.45	1.40	1.45	
	dRL response time [s]		0.20	0.20	90.0	90.0	0.10	0.10	
	doF off-Delay [s]		60	60	20	20	60	60	
F <sub>-</sub> 81.S1 81<S1	F <sub>-</sub> Alarm on/off		on	on	oFF	oFF	on	on	
	F <sub>-</sub> Underfrequency [Hz]		47.50	47.50	47.50	47.50	47.50	47.50	
	H <sub>-</sub> Hysteresis [Hz]		1.50	1.50	1.00	1.00	1.00	1.00	
	dRL response time [s]		0.20	0.20	20.0	20.0	0.10	0.10	
	doF off-Delay [s]		60	60	20	20	60	60	
F <sub>--</sub> 81.S2 81<S2	F <sub>--</sub> Alarm on/off		oFF	oFF	on	on	oFF	oFF	
	F <sub>--</sub> Underfrequency [Hz]		47.50	47.50	46.90	46.90	47.50	47.50	
	H <sub>--</sub> Hysteresis [Hz]		1.50	1.50	1.00	1.00	1.00	1.00	
	dRL response time [s]		0.20	0.20	0.50	0.50	0.10	0.10	
	doF off-Delay [s]		60	60	20	20	60	60	





Display of the program:

Info → Pr

Display of the firmware version:

Info → Fnr



(or when switching on)

		 Finland SFS-EN50549-1+2:2019	 Ireland EN50549-1 2-stage	 Netherlands NEN-EN50549-1:2019	 France VDE 0126 VFR2019		
		3AC+N 230 V	3AC 400 V	3AC+N 230 V	3AC 400 V	3AC+N 230 V	3AC+N 230 V
		Pr30	Pr31	Pr32	Pr33	Pr34	Pr36
5trt	5trt Starting conditions	oFF	oFF	oFF	oFF	oFF	oFF
	5tU <sup>-</sup> Overvoltage [V]	253	438	254	463	253	261
	5tU <sub>-</sub> Undervoltage [V]	196	338	196	337	196	187
	5tF <sup>-</sup> Overfrequency [Hz]	51.00	51.00	50.15	50.15	50.10	50.05
	5tF <sub>-</sub> Underfrequency [Hz]	49.00	49.00	47.90	47.90	48.50	48.50
	don Switch-on time [s]	60	60	20	20	60	60
nFr	nFr Alarm on/off	oFF	oFF	oFF	oFF	oFF	oFF
	U <sub>-</sub> Undervoltage [V]	196	339	196	339	196	196
	HU <sub>-</sub> Hysteresis U <sub>-</sub> [V]	3.0	3.0	3.0	3.0	3.0	3.0
	3U0 3U0 voltage [V]	115	115	115	115	115	115
	H3U0 Hysteresis 3U0 [V]	1.0	1.0	1.0	1.0	1.0	1.0
	dRL Response time [s]	0.05	0.05	0.05	0.05	0.05	0.05
	doF Off-delay [s]	60	60	20	20	60	60
UFon	UFon switching conditions	oFF	oFF	oFF	oFF	oFF	oFF
UonF	UonF on/off	oFF	oFF	oFF	oFF	oFF	oFF
	UonF voltage [V]	46.0	46.0	46.0	46.0	46.0	46.0
78	u5r Alarm on/off	5b95	5b95	5b95	5b95	5b95	5b95
	u5r Vector shift [°]	10.0	10.0	50.0	50.0	10.0	10.0
	doF off delay [s]	3	3	20	20	60	3
	dEon Suppression time [s]	2	2	2	2	2	3
	U5r Number of phases	3Ph	3Ph	1Ph	1Ph	3Ph	3Ph
81r	rocF Alarm on/off	oFF	oFF	on	on	oFF	oFF
	dFdE delta f / delta t [Hz/s]	2.000	2.000	1.000	1.000	0.800	0.800
	PEr periods	20	20	20	20	20	20
	dRL response time [s]	0.50	0.50	0.60	0.60	0.10	0.10
	doF off delay [s]	60	60	20	20	60	60
59v0	U-0 Alarm on/off	oFF	oFF	oFF	oFF	oFF	oFF
	U-0 Zero voltage [V]	46.0	80.0	46.0	80.0	46.0	46.0
	H-0 Hysteresis [V]	10.0	10.0	10.0	10.0	10.0	10.0
	dRL Response time [s]	1.50	1.50	1.50	1.50	1.50	1.50
	doF off-delay [s]	60	60	60	60	60	60
rEL	ErEL Response time Y1, Y2 [s]	oFF	oFF	oFF	oFF	oFF	oFF
	RtE reclosing attempts	2	2	2	2	2	2
	doFR mode	Ind	Ind	Ind	Ind	Ind	Ind
	doFR off-delay All [s]	0	0	0	0	0	0
ddi	ddi Display Delay [s]	0.5	0.5	0.5	0.5	0.5	0.5
	di t Display Duration 5Cn [s]	3.5	3.5	3.5	3.5	3.5	3.5
Si	U Voltage [V]	230	400	230	400	230	230
	F Frequency [Hz]	50.00	50.00	50.00	50.00	50.00	50.00
	U5r Vector shift [°]	0.0	0.0	0.0	0.0	0.0	0.0
CodE	Pin Pincode	504	504	504	504	504	504
	CodE on/off	oFF	oFF	oFF	oFF	oFF	oFF
Info	Fnr Firmware version	0-38	0-38	0-38	0-38	0-38	0-38
	Snr Serial number	xxx	xxx	xxx	xxx	xxx	xxx
	h operating hours [h]	xxx	xxx	xxx	xxx	xxx	xxx
	Err Error Counter	xxx	xxx	xxx	xxx	xxx	xxx
	Pr Program	30	31	32	33	34	36

## 20.5 NRS097 + AS4777,2

When changing programs, all parameters are reset to the default settings.

- Parameter can be changed without unlocking code lock

			 South Africa NRS097	 Australia AS4777,2	
			3AC+N 230 V	3AC 400 V	3AC+N 240 V
Menu	Parameter	My Data	Pr40	Pr41	Pr42
U <sup>---</sup> 59.S2 59>S2	U <sup>---</sup> Alarm on/off		on	on	oFF
	U <sup>---</sup> Overvoltage [V]		276	478	264
	H <sup>---</sup> Hysteresis [V]		3.0	3.0	5.0
	dRL response time [s]		0.16	0.16	1.80
	doF off-Delay [s]		60	60	60
U <sup>-</sup> 59.S1 59>S1	U <sup>-</sup> Alarm on/off		on	on	on
	U <sup>-</sup> Overvoltage [V]		253	438	260
	H <sup>-</sup> Hysteresis [V]		3.0	3.0	5.0
	dRL response time [s]		2.00	2.00	1.80
	doF off-Delay [s]		60	60	60
UN <sup>-</sup> 59-Av	UN <sup>-</sup> Alarm on/off		oFF	oFF	on
	UN <sup>-</sup> Overvoltage [V]		253	438	255
	HN <sup>-</sup> Hysteresis [V]		3.0	3.0	5.0
	dRL response time [s]		0.10	0.10	2.00
	doF off-Delay [s]		60	60	60
U <sub>-</sub> 27.S1 27<S1	U <sub>-</sub> Alarm on/off		on	on	on
	U <sub>-</sub> Undervoltage [V]		196	339	180
	H <sub>-</sub> Hysteresis [V]		3.0	3.0	5.0
	dRL response time [s]		10.0	10.0	1.80
	doF off-Delay [s]		60	60	60
U <sub>--</sub> 27.S2 27<S2	U <sub>--</sub> Alarm on/off		on	on	oFF
	U <sub>--</sub> Undervoltage [V]		115	199	146
	H <sub>--</sub> Hysteresis [V]		2.0	2.0	5.0
	dRL response time [s]		0.20	0.20	1.80
	doF off-Delay [s]		60	60	60
F <sup>---</sup> 81.S2 81>S2	F <sup>---</sup> Alarm on/off		oFF	oFF	oFF
	F <sup>---</sup> Overfrequency [Hz]		5150	5150	5200
	H <sup>---</sup> Hysteresis [Hz]		1.45	1.45	1.50
	dRL response time [s]		0.10	0.10	2.00
	doF off-Delay [s]		60	60	60
F <sup>-</sup> 81.S1 81>S1	F <sup>-</sup> Alarm on/off		on	on	on
	F <sup>-</sup> Overfrequency Hz		52.00	52.00	52.00
	H <sup>-</sup> Hysteresis Hz		1.45	1.45	1.50
	dRL response time [s]		4.00	4.00	2.00
	doF off-Delay [s]		60	60	60
F <sub>-</sub> 81.S1 81<S1	F <sub>-</sub> Alarm on/off		on	on	on
	F <sub>-</sub> Underfrequency [Hz]		47.00	47.00	47.00
	H <sub>-</sub> Hysteresis [Hz]		1.00	1.00	1.50
	dRL response time [s]		0.20	0.20	1.80
	doF off-Delay [s]		60	60	60
F <sub>--</sub> 81.S2 81<S2	F <sub>--</sub> Alarm on/off		oFF	oFF	oFF
	F <sub>--</sub> Underfrequency [Hz]		47.50	47.50	47.00
	H <sub>--</sub> Hysteresis [Hz]		1.00	1.00	1.50
	dRL response time [s]		0.10	0.10	1.80
	doF off-Delay [s]		60	60	60



Display of the program:

Inf0 → Pr

Display of the firmware version:

Inf0 → Fnr

(or when switching on)

				
		South Africa NRS097	Australia AS4777,2	
		3AC+N 230 V	3AC 400 V	3AC+N 240 V
Menu	Parameter	Pr40	Pr41	Pr42
5trt	5trt Starting conditions	oFF	oFF	oFF
	5tU <sup>-</sup> Overvoltage [V]	250	435	255
	5tU <sub>-</sub> Undervoltage [V]	199	342	185
	5tF <sup>-</sup> Overfrequency [Hz]	50.55	50.55	50.50
	5tF <sub>-</sub> Underfrequency [Hz]	48.00	48.00	48.50
	don Switch-on time [s]	60	60	60
nFr	nFr Alarm on/off	oFF	oFF	oFF
	U <sub>-</sub> Undervoltage [V]	196	339	204
	HU <sub>-</sub> Hysteresis U <sub>-</sub> [V]	3.0	3.0	3.0
	3U0 3U0 voltage [V]	11.5	11.5	11.5
	H3U0 Hysteresis 3U0 [V]	1.0	1.0	1.0
	dRL Response time [s]	0.05	0.05	0.05
	doF Off-delay [s]	60	60	60
	UFon switching conditions	oFF	oFF	oFF
UonF	UonF on/off	oFF	oFF	oFF
	UonF voltage [V]	46.0	46.0	46.0
78	u5r Alarm on/off	5b95	5b95	on
	u5r Vector shift [°]	10.0	10.0	8.0
	doF off delay [s]	3	3	3
	dEon Suppression time [s]	3	3	2
	U5r Number of phases	3Ph	3Ph	3Ph
81r	rocF Alarm on/off	oFF	oFF	on
	dFdE delta f / delta t [Hz/s]	0.800	0.800	1.000
	PEr periods	20	20	20
	dRL response time [s]	0.10	0.10	1.00
	doF off delay [s]	60	60	60
59v0	U-0 Alarm on/off	oFF	oFF	oFF
	U-0 Zero voltage [V]	46.0	80.0	46.0
	H-0 Hysteresis [V]	10.0	10.0	10.0
	dRL Response time [s]	1.50	1.50	1.50
	doF off-delay [s]	60	60	60
rEL	ErEL Response time Y1, Y2 [s]	oFF	oFF	oFF
	RtE reclosing attempts	2	2	2
	doFR mode	1nd	1nd	1nd
	doFR off-delay All [s]	0	0	0
ddi	ddi Display Delay [s]	0.5	0.5	0.5
	di t Display Duration SCn [s]	3.5	3.5	3.5
5i	U Voltage [V]	230	400	240
	F Frequency [Hz]	50.00	50.00	50.00
	U5r Vector shift [°]	0.0	0.0	0.0
CodE	Pin Pincode	504	504	504
	CodE on/off	oFF	oFF	oFF
Inf0	Fnr Firmware version	0-38	0-38	0-38
	Snr Serial number	xxx	xxx	xxx
	h operating hours [h]	xxx	xxx	xxx
	Err Error Counter	xxx	xxx	xxx
	Pr Program	40	41	42