

EMPOWERING OUR WORLD
WITH CLEAN ENERGY

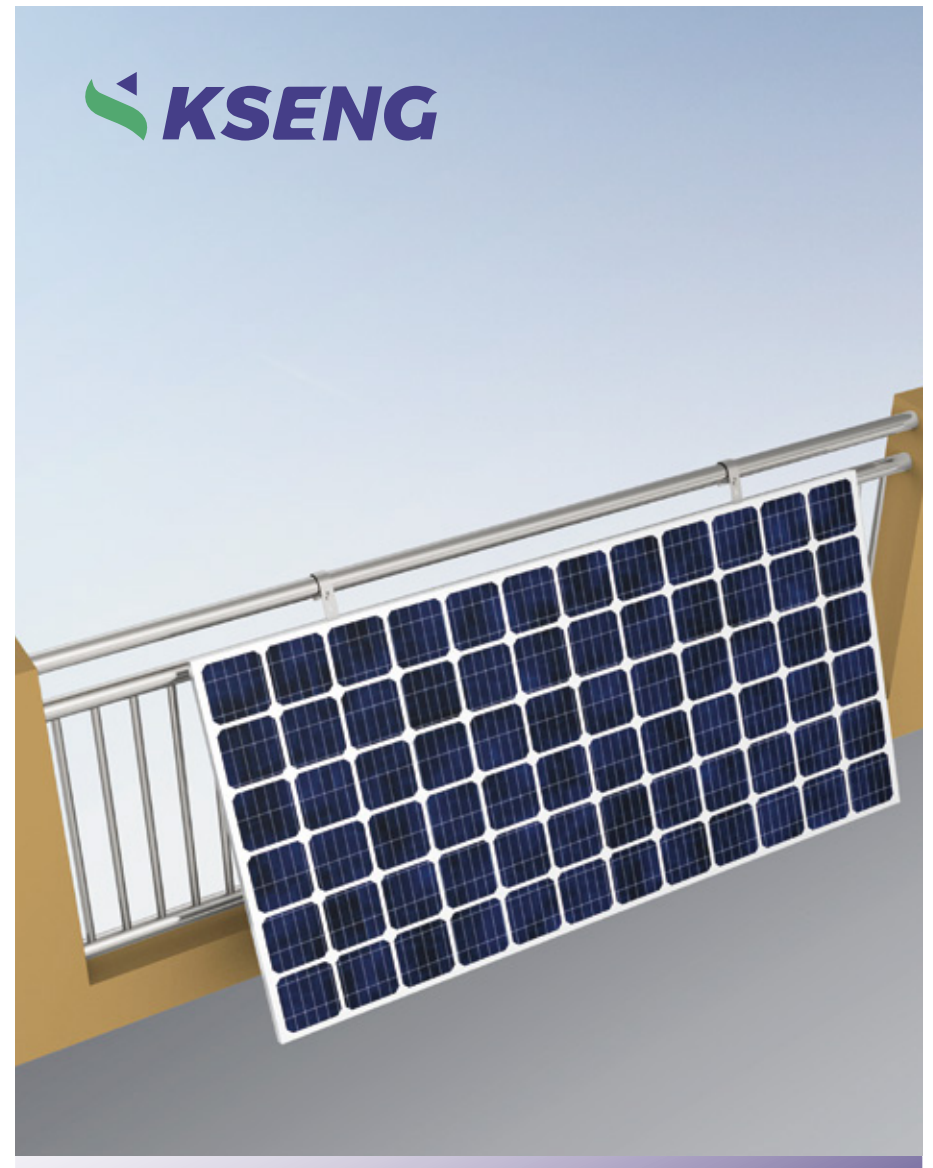

Xiamen Kseng New Energy Co., Ltd.

Email: info@xmkseng.com | **Web:** www.xmkseng.com | **Tel:** +86 0592-5777971 / +86 0592-5795673
Office Add: 6&11F, Huixin Wealth Centre, No. 891, Fanghu North 2nd Rd., Huli Dist., Xiamen, Fujian, China.



INSTALLATION MANUAL INSTALLATIONSANLEITUNG

Balcony Easy Solar Bracket (V2.0)
Einfache Solarhalterung für den Balkon (V2.0)

SC01-EBC020-KS_002

www.xmkseng.com

1. Installation tools

1. Werkzeuge für die Installation



Allen wrench
Inbusschlüssel
(M8-M12)



Tape
Meßband



Twist Wrench
Drehmomentschlüssel
(M8-M12)



Wood Hammer
Holzhammer



Electric Screw Machine
Elektroschrauber



13mm Spanner
Inbusschlüssel

2. System components

2. Komponenten des Systems

(Accessories are subject to the actual product)
(Zubehör unterliegt dem tatsächlichen Produkt)

☑ x 2



A

☑ x 2

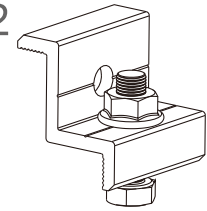

B

☑ x 2

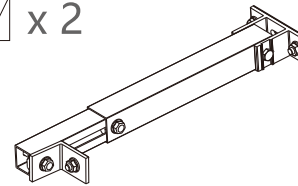

C

☑ x 2

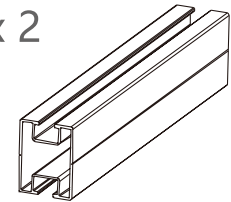

D

☑ x 2

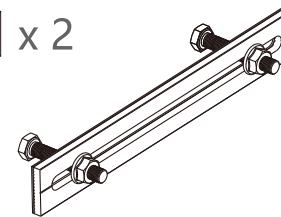

E

☑ x 2



F

☑ x 4

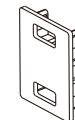





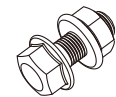





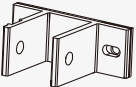
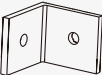

G

☑ x 3



H

Product specification
Produktspezifikation

 260mm Al 6005-T5 AlMgSi0.5	 275mm Al 6005-T5 AlMgSi0.5	 300mm Al 6005-T5 AlMgSi0.5	 38mm SUS304 1.4301
 35mm Al 6005-T5 & EPDM	 35mm Al 6005-T5 AlMgSi0.5	 40mm Al 6005-T5 AlMgSi0.5	
 30mm Al 6005-T5 AlMgSi0.5	 220mm Al 6005-T5 AlMgSi0.5	 M8*20 SUS304 1.4301	 M8*25 SUS304 1.4301
 M8*55 SUS304 1.4301	 M8*60 SUS304 1.4301	 M8*90 SUS304 1.4301	

3.Application scenarios

3.Einsatzszenarien



Fixed on balcony with 0°

Schema der Haken-Befestigung
auf dem Balkon mit Winkel 0°



Fixed on balcony with adjustable tilt
between 10°-30°;

Schema der Haken-Befestigung auf dem
Balkon mit einstellbarer
Neigung zwischen 10°-30°

4.Installation Instruction

4.Installationsanweisung

4.1 Fixed on balcony with adjustable tilt between 10°-30°

4.1 Schema der Haken-Befestigung auf dem Balkon mit einstellbarer Neigung zwischen 10°-30°

4.11 Balcony Hook installation: Hooks are attached via bolts and holes in the panel frame

4.11 Installation mit Haken auf dem Balkon: Die Haken werden mit Schrauben und Löchern im Plattenrahmen befestigt.

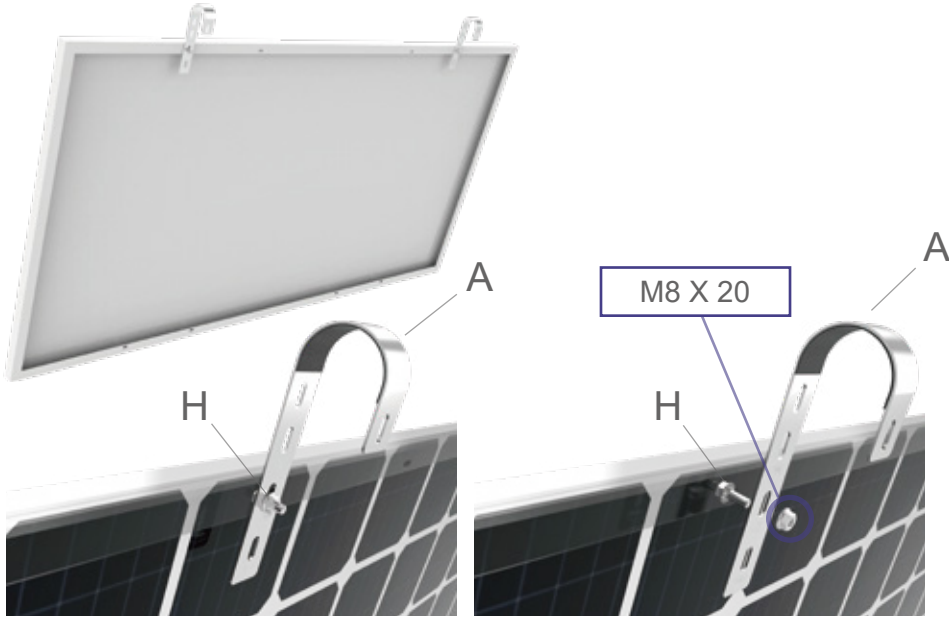

4.12 L foot installation and connection: The L foot is locked on the other side of the panel frame with bolts, and then connected with the telescopic rod with bolts. Before fixing the telescopic rod onto the frame, first lock and secure the extendable portion at the desired angle and length according to the installation requirements.

4.12 Installation und Verbindung der L-FüÙe: Arretieren Sie den L-Fuß auf der anderen Seite des Paneelrahmens mit Schrauben, und verbinden Sie ihn dann mit der Teleskopstange mit Bolzen. Bevor Sie die Teleskopstange am Rahmen befestigen, Verriegeln und fixieren Sie zunächst das Teleskopteil im Voraus entsprechend dem für die Installation erforderlichen Winkel und der Länge der Teleskopstange.

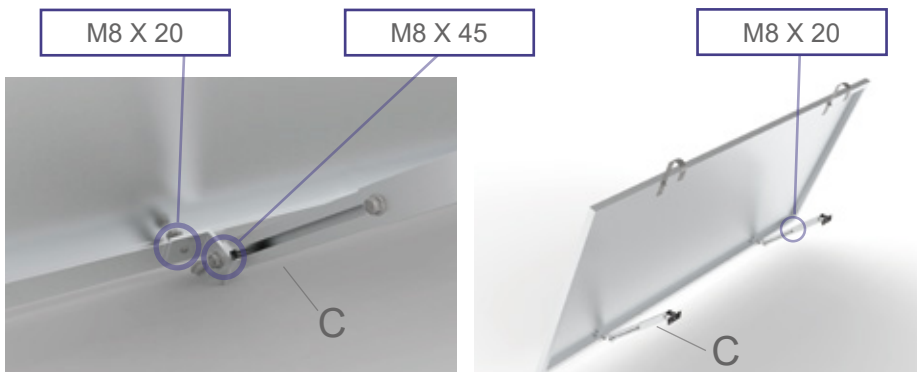

4.13 Installation of telescopic rod: The telescopic rod is pre-installed at the factory, and the base is also locked on the rail with M8 bolts;

4.13 Installation der Teleskopstange: Die Teleskopstange ist werkseitig vormontiert, der Sockel wird ebenfalls mit M8-Schrauben auf der Führungsschiene arretiert;

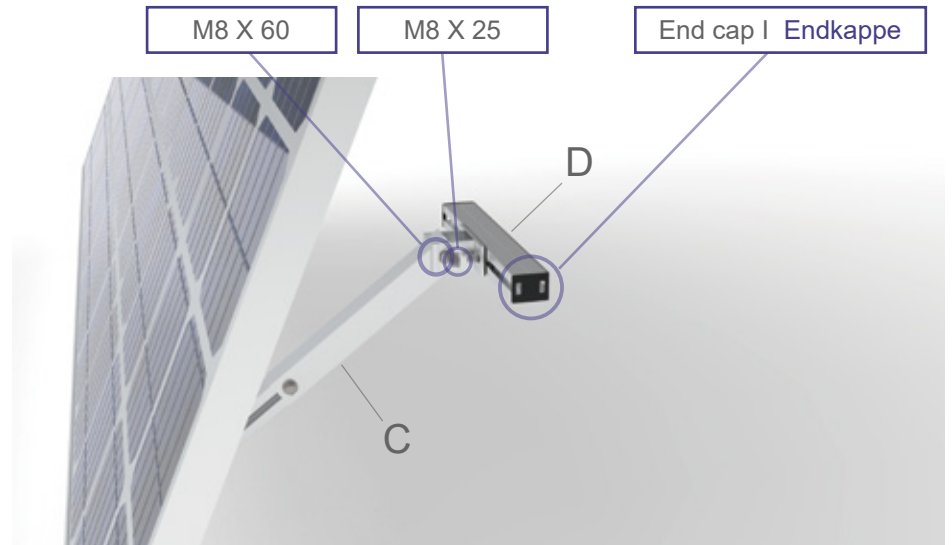
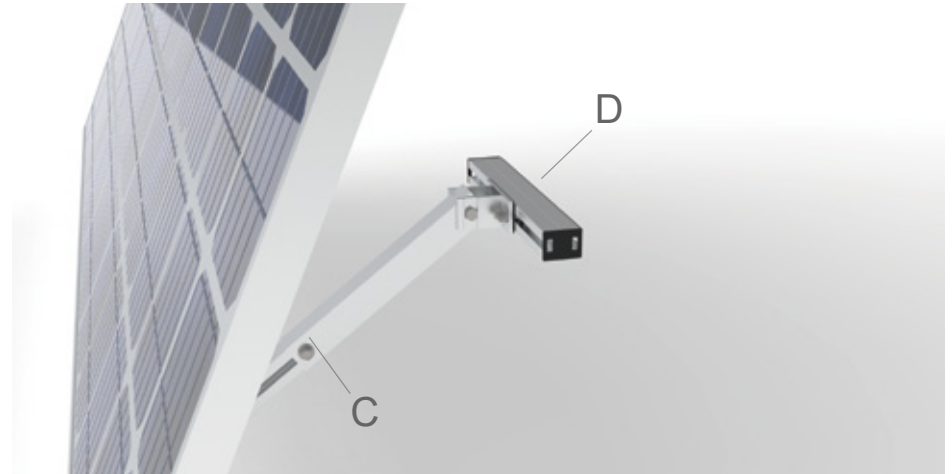

4.14 The hook and railing connection: the hook hangs on the balcony railing, through the bolt to prevent it from falling out;

4.14 Verbindung zwischen Haken und Geländer: Der Haken wird an das Balkongeländer gehängt, und der Bolzen wird hindurchgeführt, damit er nicht herausfallen kann;

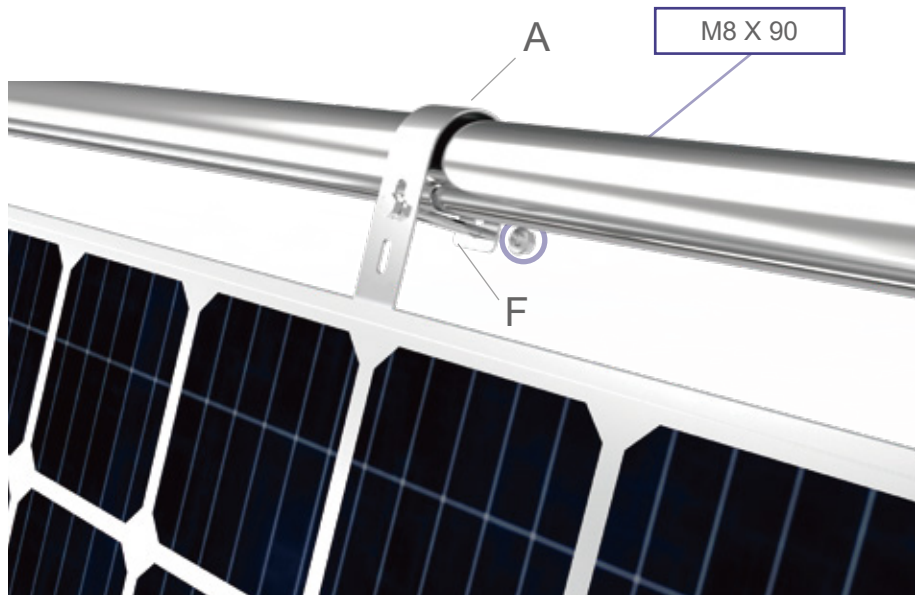

4.15 Rail installation: The bolt head snaps into the groove of the rail, the aluminum plate is on the other side of the railing, and the bolt is locked as shown in the picture;

4.15 Installation der Führungsschiene: Setzen Sie den Schraubenkopf in die Nut der Führungsschiene ein, die Aluminiumplatte befindet sich auf der anderen Seite des Geländers, und arretieren Sie die Schraube wie in der Abbildung gezeigt;

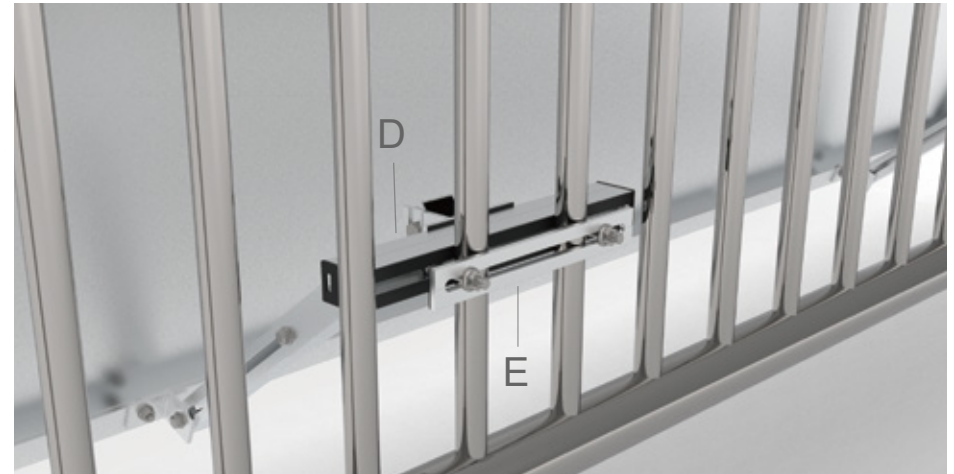

4.16 According to the required angle, adjust the position of the telescopic rod and then lock the bolt, and the installation is completed;

4.16 Passen Sie die Position der Teleskopstange an den gewünschten Winkel an, ziehen Sie die Schraube fest und schließen Sie die Installation ab;



4.2 Balcony hook without angle solution

4.2 Schema der Haken-Befestigung auf dem Balkon mit Winkel 0°

4.21 The hooks and rails are attached to the railing in the same way as the angled ones, removing the adjustable feet and L connectors. Press the panel directly on the guide rail with end clamps, as shown in the picture below. The M8 bolt head is snapped into the slot, and the nut is locked.

4.21 Der Verbindungsmodus zwischen dem Haken, der Führungsschiene und dem Geländer ist derselbe wie mit dem Winkel. Entfernen Sie den verstellbaren Fuß und das L-Verbindungsstück und drücken Sie das Panel direkt mit seitlichem Druck auf die Führungsschiene, wie in der folgenden Abbildung gezeigt; klemmen Sie den Kopf der Schraube M8 in den Schlitz und sichern Sie die Mutter;

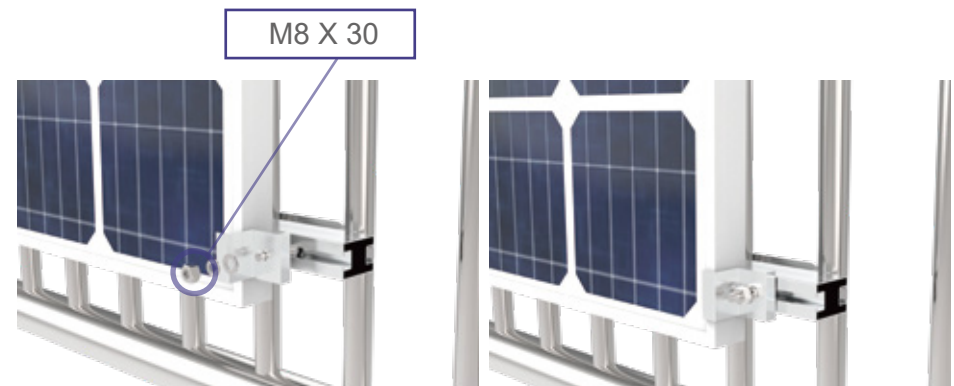

4.22 The installation is completed

4.22 Die Installation ist abgeschlossen



Purchaser/End User/Installer Notice:

Purchasers should confirm whether they are able to install this product and obtain relevant permits in accordance with local laws and regulations, including but not limited to government, community, adjacent property owners, and property rights holders.

Purchasers should engage qualified installers, professionals, or self-install only where permitted by law.

Purchasers should also ensure that the installation supports the building or its accessories safely and meets installation requirements, and is sufficient to support the product and its photovoltaic power generation system for over 20 years.

Purchasers should not install or use this product in environments with corrosive air or water, such as acids or alkalis in the vicinity.

Purchasers should fully assess and bear the consequences of product installation and usage and their impact on the surroundings, including but not limited to potential lightning strikes, electrical or magnetic conduction, light reflection/pollution, obstruction of passage, collision with people, snow accumulation and ice shedding, depreciation of buildings, and their consequences.

Purchasers are solely responsible for safety during installation, throughout the installation process, and subsequent usage, and/or any impact on third parties.

After installing the product, purchasers or their appointed installers should carry out waterproof, leak-proof, and anti-seepage construction at the junction of the product and the building to protect the building supporting the product, and conduct periodic inspections and maintenance in the future (at intervals not exceeding 1 year).

Purchasers should be aware that nothing other than the photovoltaic power generation system should be supported on this product, and no additional weight should be placed on the product during installation or subsequent usage, particularly human suspension or leaning. It should not be used for any purpose other than supporting photovoltaic brackets. Purchasers should be aware that nothing other than the photovoltaic power generation battery system should be supported on this product, and no additional weight should be placed on the product during installation or subsequent usage,

particularly human suspension or leaning. It should not be used for any purpose other than supporting photovoltaic brackets.

We shall not be liable for any consequences resulting from failure to comply with local legal requirements and/or failure to follow instructions, warnings, etc., during the installation of this product, nor shall we be liable for any losses to the supporting building or any third party resulting from the installation process or subsequent usage, nor shall we be liable for any multiple installations, disassembly and reuse, or second-hand purchases of this product.

