

ZENDURE

SuperCharged[®]

SuperBase Pro 1500 User Manual

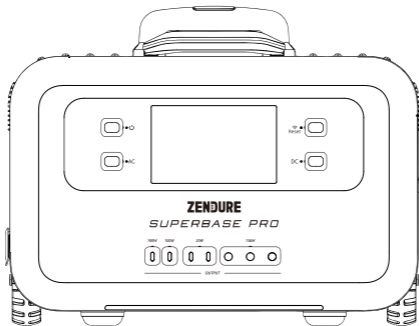

Model: ZDSBP1500

✉ support@zendure.com

DISCLAIMER

Read all safety guidelines, warnings and other product information in this manual carefully, and read any labels or stickers attached to the product before using. Users take full responsibility for the safe usage and operation of this product. Familiarize yourself with relevant regulations in your area. You are solely responsible for being aware of all relevant regulations and using Zendure products in a way that is compliant. Keep this manual for future reference.

CONTENTS

1. Specifications	1
2. Safety Guidelines	2
2.1 Usage	2
2.2 Disposal Guide	2
3. Important Tips	3
4. Getting Started	4
4.1 What's in the Box	4
4.2 Interface	4
4.3 Display	5
4.4 General Product Usage	6
4.5 AC Recharging	8
4.6 Solar Recharging	9
4.7 Car Recharging	10
4.8 Cell Network & GPS	10
4.9 AmpUp Mode	10
4.10 Offline UPS	11
4.11 Sleep Mode	11
5. FAQs	12
6. Troubleshooting	13

1. Specifications

General	
Weight	≈ 41.45lbs /18.8kg
Dimensions	17.5 × 10.5 × 13.8in / 446 x 276 x 352mm
Capacity	1,440Wh (30Ah/48V)
Wireless Type	Wi-Fi
Cell Network & GPS	Supported
Outputs	
6*AC Ports	Pure Sine Wave, rated 2,000W (surge 4,000W), 100-120V~50/60Hz (US, JP version) or 220-240V~50/60Hz (Other versions)
4*USB-C Ports	USB-C1/2: 5-20V, 100W Max Each USB-C3/4: 5-12V, 20W Max Total
1*Car Charger Port	13.6V⎓10A, 136W** Max
3*DC5521 Output Ports	13.6V⎓10A, 136W** Max Total

* The EU version has 4 AC Outlets

**136W refers to the combined maximum output power of the Car Outlet and the DC5521 ports together.

Inputs	
AC Charge	1,800W Max,(1500W,JP) 100-120V~50/60Hz (US, JP version) or 220-240V~50/60Hz (Other versions)
Solar Charge	12-60Vmp 10A DC, 600W Max via XT60 input 60-160Vmp 11A DC, 1,800W Max via AC input Total AC+DC MPPT,2400W
Car Charge	Supports 12V/24V⎓10A Battery

SuperBase Pro cannot support AC output while recharging by solar charge via AC input port.

Battery	
Cell Chemistry	LiFePO4
Warranty	2 years
Cycle Life	6,000 cycles
Temperature	
Optimal Operating Temperature	59°F to 95°F (15°C to 35°C)
Discharge Temperature	-4°F to 140°F (-20°C to 40°C)
Charge Temperature	32°F to 110°F (0°C to 40°C)
Storage Temperature	32°F to 110°F (0°C to 45°C)

*The temperature mentioned above is allambient temperature

2. Safety Guidelines

2.1 Usage

- 1.Store product in a cool and dry place.
- 2.Do not dispose of the product in heat or fire.
- 3.Do not expose to moisture or submerge it in liquid.
- 4.Do not use around strong static electricity or magnetic fields.
- 5.Do not disassemble the product. Consult official Zendure channels when service or repair is required. Incorrect disassembly or reassembly may result in a risk of fire or injury to persons.
- 6.When using the product, please strictly follow the operating environment temperature range specified in the user manual. If the temperature is too high, it may result in a fire or explosion; if the temperature is too low, the product performance may be severely reduced, or the product may cease to work.
- 7.Do not block or obstruct the fan during use or place the product in an unventilated or dusty area.
- 8.Ensure the product is not hit, dropped, or heavily vibrated. Securely fasten the product when transporting to avoid damage. If severely damaged, turn off the power source immediately and discontinue using the product.
- 9.If you accidentally drop the product into water during use, please place it in a safe open area, and stay away from it until it is completely dry. The dried product should not be used again and should be properly disposed of according to the Disposal Guide section of this manual.
- 10.Only clean the ports with a dry cloth.
- 11.Place on a flat surface to keep the product from falling over. If the product is overturned and severely damaged, turn it off immediately, place the battery in an open area, keep it away from people and combustibles, and dispose of it in accordance with local laws and regulations.
- 12.Keep out of reach of children and pets.

2.2 Disposal Guide

- 1.When possible, fully discharge the battery before disposing of it. Consult your local laws on battery recycling and disposal.
- 2.If the battery cannot be fully discharged due to product failure, contact a professional battery recycling company for further processing.
- 3.When disposing of secondary cells or batteries, keep cells or batteries of different electrochemical systems separate from each other.

3. Important Tips



It is recommended to use this product in an environment of 15°C-35°C, away from water, fire and other sharp objects.



For long-term storage, please charge and discharge this product once every 3 months. That is, discharge the product to 30% first, and then recharge it to 60%.



For safety reasons, do not store this product in an environment above 45°C or below 0°C for a long time.



If the power of this product is lower than 1% after using, please charge it to 60% before storing it. Because the battery is left idle for a long time when the power is seriously insufficient, it will cause irreversible damage to the battery and shorten the service life of the product.



Do not disassemble the product. When service or repair is required, please consult official Zendure channels. Improper disassembly or reassembly may result in a risk of fire or personal injury.

4. Getting Started

4.1 What's in the Box



SuperBase Pro 1500



Quick Guide



Warranty Card



Accessory Pouch



MC4 to XT60 Cable 3m
Solar Charge via DC



AC Cable 1.5m
AC Input



MC4 to AC Cable 3m
Solar Charge via AC



USB-C to USB Adapter

4.2 Interface

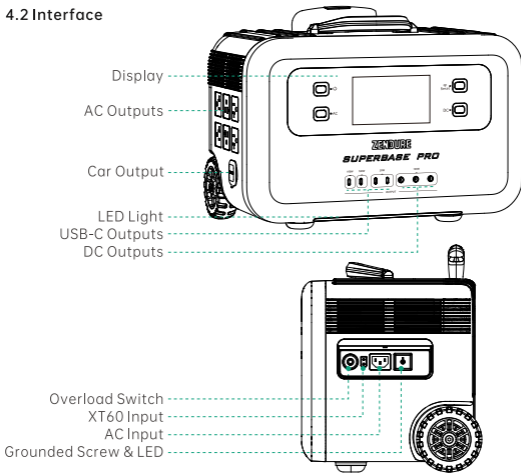

4.3 Display

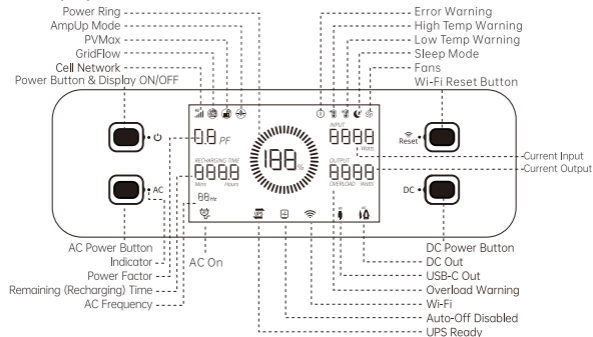

Power Button&Display ON/OFF

- Press 1 second to turn ON SBP1500, long press 3 seconds to turn OFF SBP1500.
- Short press to turn OFF the Display and Ambient Light.

AC Power Button

- Short press to turn ON/OFF AC Output.
- Long press 3 seconds to change frequency (60Hz/50Hz, Applicable to the Kanto and Kansai regions of Jp).

DC Power Button

- Short press to turn ON/OFF DC Output (USB port for direct output, not controlled).
- Long press 3 seconds to turn ON/OFF 4G.

Wi-Fi Reset Button

- Long press 3 seconds to start WiFi connecting.
- Short press to disconnect WiFi.

SBP1500 Reset

- Long press (Power button + AC button + DC button) 5 seconds to Reset the device

Indicator Tips

- The device is really turned off when the power light goes out, so when turning off the device, please check if the power light goes out.
- If using UPS, the AC input must be connected to the grid and the AC output must be on. Both Power and AC indicators must be on at the same time.
- Wi-Fi indicator starts flashing and the device enters Wi-Fi connecting mode; after completing Wi-Fi connection, the indicator keeps green light and offline goes out.
- DC5521/Car charger output, DC Output button must be on, the indicator must be on.

Display Tips

- Power Ring: The ring fills up as the battery is charging. If the product is at 5% charge or less, the ring will flash.
- Wi-Fi Status: Long press the Wi-Fi button 3s, the Wi-Fi icon flashes, and it starts connecting to Wi-Fi; after a successful connection, the icon remains on. If there is no network available, the icon will keep flashing 5 min then go out.
- Cell Network: Long press the DC button 3s, the cell network icon flashes, start connecting to a mobile network; after a successful connection, the icon remains on. If there is no network available, the icon will keep flashing 5 min then go out.

4.4 General Product Usage

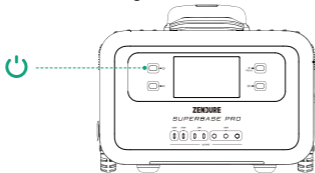

Press for 1s to Turn On, Long Press for 3s to Turn Off

4.41 Startup, Power Off, Display On

- Press the Power Button for 1 second to turn on the product; the Display will light up and the power ring indicator will display.
- The Display will automatically turn off after 1 minute of idle operation. You can change this through the Zendure App. When the product senses any load change or other changes to its operations, the Display will automatically light up.
- To power off the product, press and hold the Power Button for 3 seconds.
- The default product standby time is 1 hour. With other buttons turned off and no other load access for 1 hour, the product will automatically shut down. The standby time can be set in the Zendure App.

4.42 Zendure App

The Zendure App gives users the ability to control and monitor their Zendure power stations remotely.

Read the Zendure App user guide and access the download link here:

<https://zendure.com/pages/download-center>



Privacy Policy

By using Zendure Products, Applications and Services, you consent to the Zendure Terms of Use and Privacy Policy, which you can access via the "About" section of the "User" page in the Zendure App.

*Add device and Update to the latest firmware version

Using the device for the first time, you need to update the firmware via the Zendure App.

More information, Please check the Zendure App user guide.

*Battery Capacity Calibration

Using the device for the first time, you need to calibrate the battery capacity, as follows:

First discharge the left power of the product, and then let the device charge to 100%, then you have completed the capacity calibration.

*Standby Time Setting

The default product standby time is 1 hour. With other buttons turned off and no other load access for 1 hour, the product will automatically shut down. The standby time can be set in the Zendure App. For energy saving, keep SuperBase Pro1500 power off when the device is not in use.

4.43. Press "DC ON/OFF" button and "AC ON/OFF" button to enjoy the equipment using

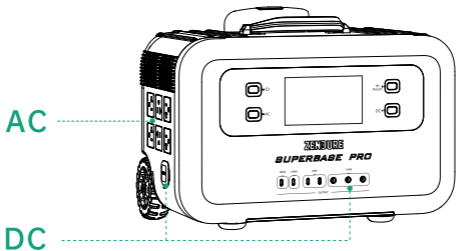

Tips:

- The DC Power button only controls 12V DC output, that is, 3*5521 and Car output, not including USB-type C port which can output directly.
- If the AC or DC power is on, the device will always be in standby, for energy saving, keep the AC and DC power off when the device is not in use.
- If the load power is less than 25W and the DC or AC power button is not turned on, the SuperBase pro 1500 will default to without load. After 1 hour of standby, it will automatically shut down to save power.

4.5 AC Recharging

Zendure's GridFlow fast charge technology is specifically for AC recharging, offering 1,800W of maximum input power. This limit can be modified in the Zendure app. In case of unusual situations where the AC input current remains higher than 20A, the AC input port will initiate a self-protection function, and the Overload Switch on the product will automatically pop up. After confirming that there is no product failure, you can press the Overload Switch to resume charging.

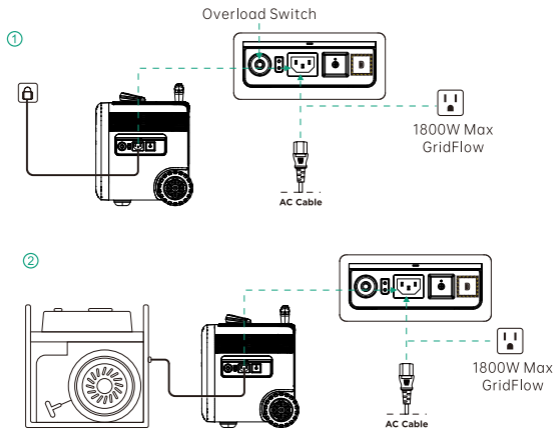

Tips:

- You can set the charging power in the Zendure App.
- Please use the AC Charging Cable included in the package for fast charging. Do not use other cables to charge. Plug directly into an AC wall outlet and make sure that the wall outlet and circuit are rated for more than 15A. Otherwise, reduce the unit charging speed via the Zendure App. Zendure assumes no responsibility for any consequences of product misuse, including but not limited to charging with an unsuitable wall outlet, circuit, or power cable.
- AC GridFlow charging cannot be stopped via the Zendure App, if you need to stop it, please unplug it manually.

4.6 Solar Recharging

Users can connect solar panels in series as shown in the figure to recharge the product. The product supports 12-160Vmp DC input, 11A max current, and 1,800W max charging power.

600W Max via XT60 Input Port, 12-60Vmp DC

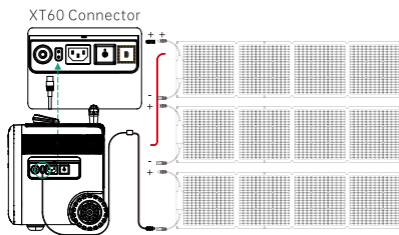

MC4 Connector

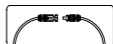

1,800W Max via AC Input, 60-160Vmp DC, PVMax

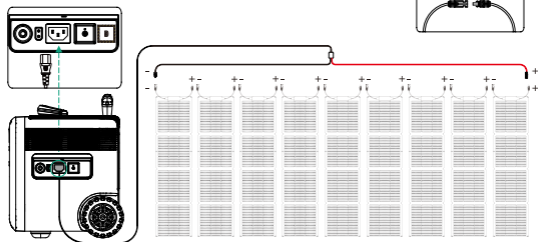

MC4 Connector

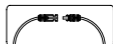

Tips:

- SBP1500 not support Dual MPPT

(AC 1800W+XT60 600W, charging at the same time, the battery only support 1800W input)

4.7 Car Recharging

Users can recharge the product through the car cigarette lighter socket.

Tips:

- Please recharge using the car charger only while the car's engine is running, to avoid draining your car's battery.
- In addition, please make sure that the cigarette lighter port of the Car Outlet and the Car Charger Input Cable (not included) are in good condition. Zendure assumes no responsibility for any loss, damage, or injuries caused by misuse.

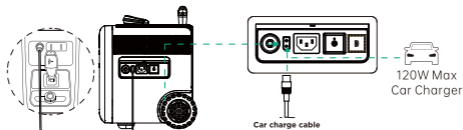

4.8 Using Cell Network & GPS

Tips:

- Only long press the DC button 3s to activate the 4G connection, and the GPS synchronously. Cell Network & GPS cannot be deactivated through Zendure APP.
- Cell Network & GPS recommended use in outdoors where without WIFI but with strong GPS satellite signal.

You can manually turn off the cell network or GPS services in the Zendure App. The signal strength of cell networks and GPS services can vary. If you have any questions, please contact the Zendure team for support.

4.9 AmpUp Mode

With Zendure AmpUp technology, the product can power a 3,000W max device while the rated output power remains 2,000W, avoiding operation failure due to overload protection.

You can turn on AmpUp Mode in the Zendure App.

AmpUp Tips:

1. AmpUp is not available when the AC output is turned on in a recharging state (in bypass mode).
2. AmpUp is not applicable for all electrical appliances; it's incompatible with appliances that have strict voltage requirements and a rated power over 2,000W. Appliances with voltage protection (such as precise instruments) are not supported. AmpUp mode is more suitable for heating devices. When using AmpUp with an untested device, please monitor its performance for any irregularities.

4.10 Offline UPS

This product supports 13ms offline UPS.

When you connect the grid power to the AC Input Port of the product through an AC cable, you can power electrical devices through the AC Output Port (AC power will come from the grid and not the power station in this situation).

In case of a sudden blackout, the product can automatically switch to the battery-powered supply mode within 13ms. As an offline UPS, this function does not support 0ms switching.

Please do not connect the product to any device that requires 0ms UPS, such as data servers and workstations.

Please test and confirm compatibility before using the product as a UPS.

We recommend that you only charge one device at a time and avoid using multiple devices simultaneously to avoid triggering overload protection. Zendure assumes no responsibility for any device failures or data losses caused by misuse of this product.

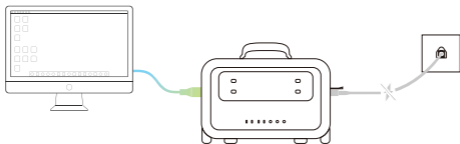

Tips:

- If wanting to use Offline UPS, please keep the grid power connecting to the AC Input Port with an AC cable, the AC power button is on and connect to the device you need SBP1500 to be powered.

4.11 Sleep Mode

- With Sleep Mode activated, SuperBase Pro will reduce the input power, deactivate the ambient light, and turn off all sounds.
- You can turn on Sleep Mode in the Zendure App.
- Any changes to input power setting, light, sound or standby time of the display will deactivate Sleep Mode.

5. FAQs

1. What are the charging methods for SuperBase Pro 1500?

- SuperBase Pro 1500 supports 5 charging methods.
- Household AC socket (15A max);
- Solar panel AC port charging (1800W, 11A max);
- Solar panel XT60 charging (600W 11A max);
- Alternator charging (1800W);
- Car charger (charging when starting the engine, 12/24V 10A max);

2. Can I use a third-party solar panel to charge my SuperBase Pro 1500?

Yes, please confirm that the solar panel specifications are within this range: 12-200Voc and the Current is within 11A.

3. What devices can the product's AC output port power?

With 2,000W rated power and 4,000W peak power, the product's AC output port can power most household appliances. Before you use it, we recommend that you confirm the power requirements of your appliances and ensure the total power of all loaded appliances is lower than the rated power.

4. Can I charge it at 50HZ and then output through 60HZ when using it?

Yes, the device will detect the frequency required by your electrical equipment and switch automatically, or you can switch manually. But in UPS mode, the frequency requirements of the electrical equipment should be consistent with the grid, because in this mode SuperBase Pro 1500 has no way to coordinate them.

5. What is the life expectancy of the SuperBase Pro 1500?

SuperBase Pro 1500 has a cycle life of 3000 times to 80%. It is worth noting that charging from 0% to 100% and then to 0% is only one cycle. And we recommend setting the charging to 80% as much as possible and no longer charging. This allows the product to last longer. You can set the charging limit in the APP.

6. Can SuperBase Pro 1500 input and output at the same time?

Yes, SuperBase Pro 1500 Can input via AC input and DC output at the same time. If XT60 input, the AC output and DC output can also output at the same time.

7. How long will the SuperBase Pro 1500 run my device?

Working time (H) = 1440WH* 0.92 / working power of the device (W). You can refer to this formula to estimate the working time of your equipment. And it should be noted that the sum of the equipment power cannot exceed 2000w.

8. My device is not responding or is behaving strangely, what should I do?



1. The device does not respond (the screen is not bright), you can charge the device with commercial power first, and observe whether there is a sound of the fan rotating when charging;
2. Press and hold the power button for 3 seconds to restart the device, then charge through the DC channel, and feedback the power during DC charging;
3. Press the power button + AC + DC at the same time for 5 seconds to reset the device, then charge through the DC channel and feedback the DC charging power;
4. Send us the SN number, and make sure that the device has been connected to the 4G network and power supply, and we will check the data processing through the background. To bind the SBP to the APP, please refer to the video guide linked below.

<https://drive.google.com/file/d/1OTAtHxfkdpkywGAgz5cOUIEx2LEp2VtC/view?usp=sharing>

9. Can't receive the verification code when registering an account?

Please check if the verification code is in the spam of your mailbox.

6. Troubleshooting

Indicator (Flash)	Issue	Troubleshooting
OVERLOAD	Overload Protection	Normal operation will be resumed automatically after you remove the overloaded device and restart the product. Electrical appliances should be used within rated power.
	High Temperature Protection	It can be resumed automatically after the battery cools down.
	Low Temperature Protection	It can be resumed automatically after the battery temperature rises above 32°F (0°C).
	Error Warning	Contact Zendure Customer Service for further information.
/	Reset method	<p>Reset method: Press and hold 3 buttons (power button + AC button + DC button) at the same time for 5 seconds, when you hear a "di", the SBP starts to reset.</p> <p>Applicable scenarios for reset:</p> <ol style="list-style-type: none"> 1. Can't connect to the internet. 2. Failed to bind the SuperBase Pro. 3. The screen is off and the button light is on. 4. There is no output from the type-C port. 5. The screen is abnormal. 6. The screen is frozen. 7. Crash.
/	Inaccurate battery display	<p>Battery calibration: After OTA or manually burning the firmware, discharge the device to 0% power (for example, the power of the device used by the user cannot be discharged to 0%, and there is a little remaining power, so that the device can run out of remaining power with no load).</p> <p>And then connect the charging cable to charge the device to 100% power (the charging power can be set to any one of the 5 levels), until the charging power reaches 50W and below, that is, the SOC learning is completed.</p>